

Energy efficient

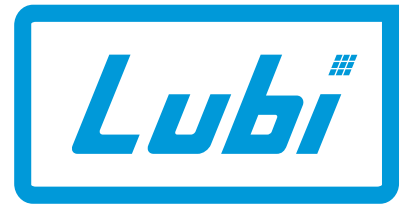

PUMPS • MOTORS

ISO 9001 Company



Pumping Solution

60 Hz



Photographs of a few Manufacturing Units

TUV SÜD TUV SÜD TUV SÜD TUV SÜD TUV SÜD TUV SÜD TUV SÜD TUV SÜD TUV SÜD TUV SÜD TUV SÜD TUV SÜD TUV SÜD TUV SÜD TUV SÜD TUV SÜD TUV SÜD TUV SÜD TUV SÜD TUV SÜD

ZERTIFIKAT ◆ CERTIFICATE ◆ 認證證書 ◆ CERTIFICADO ◆ CERTIFICAT



Management Service

CERTIFICATE

The Certification Body
of TÜV SÜD Management Service GmbH
Trading as TÜV SÜD South Asia Private Limited

certifies that



LUBI INDUSTRIES LLP [DIV.05]
A - 2, Lubi Industrial Park, Vadsar Khatraj Road, Vadsar
Dist. Gandhinagar- 382 721, Gujarat, INDIA

has established and applies
a Quality Management System for

**"Manufacturing, Supply and Service of Stainless Steel
Fabricated Submersible Pump Sets, Horizontal and Vertical
Multistage Centrifugal Pump Sets."**

An audit was performed, Report No. **707021650**.

Proof has been furnished that the requirements
according to

ISO 9001:2008

are fulfilled. The certificate is valid in conjunction
with the main-certificate from **2014-02-04** until **2017-02-03**.

Certificate Registration No. **12 100 47334/02 TMS**

Product Compliance Management
Munich, 2014-02-10



Contents

Stainless steel submersible bore well pumps

Product data		6" Performance curves/technical data	
Introduction	5	J6 - 6" Radial flow	30
Operating conditions	5	J9 - 6" Radial flow	34
Type keys	5	J12 - 6" Radial flow	38
Pumped liquids	5	J17 - 6" Radial flow	42
Curve conditions	5	J17A - 6" Radial flow	46
		J20 - 6" Radial flow	50
Performance range	6	J24 - 6" Radial flow	54
		J13H - 6" Radial flow	58
Product range	7	J16H - 6" Radial flow	60
		J18H - 6" Radial flow	62
Features and benefits	8	W17 - 6" Mixed flow	64
		W30 - 6" Mixed flow	68
		W46 - 6" Mixed flow	72
		W60 - 6" Mixed flow	76
Design features	10	<u>8" Submersible pump</u>	81
		8" Product data	
<u>4" Submersible pump</u>	11	Construction	82
4" Product data		Applications	82
Construction	12	Performance range	82
Applications	12	Operating conditions	82
Performance range	12	Special construction on request	82
Operating conditions	12	8" Construction	
Special construction on request	12	Sectional drawing	83
		Materials	83
4" Construction		8" Performance curves/technical data	
Sectional drawing	13	W77 - 8" Mixed flow	84
Materials	13	W95 - 8" Mixed flow	88
4" Performance curves/technical data		<u>10" Submersible pump</u>	93
W1A - 4" Radial flow	14	10" Product data	
W2A - 4" Radial flow	16	Construction	94
W3A - 4" Radial flow	18	Applications	94
W5A - 4" Radial flow	20	Performance range	94
W8A - 4" Mixed flow	22	Operating conditions	94
W14A - 4" Mixed flow	24	Special construction on request	94
<u>6" Submersible pump</u>	27	10" Construction	
6" Product data		Sectional drawing	95
Construction	28	Materials	95
Applications	28	10" Performance curves/technical data	
Performance range	28	W125 - 10" Mixed flow	96
Operating conditions	28	W160 - 10" Mixed flow	100
Special construction on request	28	W215 - 10" Mixed flow	102
6" Construction		Friction loss tables	104
Sectional drawing	29	Discharge rate table	106
Materials	29	Conversion tables	107

Product data



Stainless steel submersible bore well pumps

Introduction

Submersible bore well pumps for 4" wells (DN 100 mm), 6" (DN 150 mm), 8" (DN 200mm) and 10" (DN 250 mm) are constructed completely out of stainless steel AISI 304 (stainless steel AISI 316 material available on request).

Sized for connection to the motor according to NEMA standards up to 8" motor joining.

Delivery casing with built-in non-return valve.

Impellers:

Radial flow impellers

- 4": W1A, W2A, W3A, W5A
- 6": J6, J9, J12, J17, J17A, J20, J24, J13H, J16H, J18H

Mixed flow impellers

- 4": W8A, W14A
- 6": W17, W30, W46, W60
- 8": W77, W95
- 10": W125, W160, W215.

Connection:

Screwed pipe connection with NPT thread as standard.

BSP thread pipe connection are available on request.

Operating conditions

- Flow range: Max. 1475 USgpm
- Head range: Max. 2231 feet
- Liquid temperature: +32°F to 113°F
- Max. sand content into the water: 50 g/m³.

Type keys

Example	W	46	-5	-A	B	N
Type range (W & J)						
Pump type						
Number of impellers						
First impeller with reduced diameter (A, B or C)						
Second impeller with reduced diameter (A, B or C)						
Stainless steel parts of material						
= AISI 304 (DIN W.-Nr. 1.4301) (Standard construction)						
N = AISI 316 (DIN W.-Nr. 1.4401)						

Pumped liquids

These pumps are designed for liquids which are thin, clean, non-aggressive, non-explosive, not containing solid particles or fibres.

Special versions made of stainless steel AISI 316 are available for applications involving aggressive liquids.

Curve conditions

The conditions below apply to the curves shown the following pages.

General

- Tolerances in accordance with ISO 9906, Annex A.
- The motors used for the measurement are standard motors.
- Test results with clean cold water, without gas content. Measurements have been made with airless water at a temperature of 68°F.
- Head and power values valid for liquids with density $\rho = 1,0 \text{ kg/dm}^3$ and kinematic viscosity $\nu = \max 1 \text{ mm}^2/\text{s}$ (1 cSt).
- When pumping liquids with a density higher than that of water, motors with correspondingly higher outputs must be used.
- The QH curves apply to a rated motor speed of 3450 min⁻¹.
- The performance curves are inclusive of possible losses such as non-return valve losses.
- A safety margin of + 2 feet is recommended for the NPSH value.

4" curves

- **QH:** The curves are inclusive of valve and inlet losses at the actual speed.
- **Power curve:** The power curve shows pump power input at the actual speed for one stage.
- **Efficiency curve:** $\eta_p\%$ shows pump stage efficiency.

6", 8" & 10" curves

- **QH:** The curves are inclusive of valve and inlet losses at the actual speed.
Operation without non-return valve will increase the actual head at nominal performance by 2 to 3.3 feet.
- **NPSH:** The curve is inclusive of suction interconnector and shows required inlet pressure.
- **Power curve:** The power curve shows pump power input at the actual speed for one stage.
- **Efficiency curve:** $\eta_p\%$ shows pump stage efficiency.

Performance range

Stainless steel submersible bore well pumps

J & W

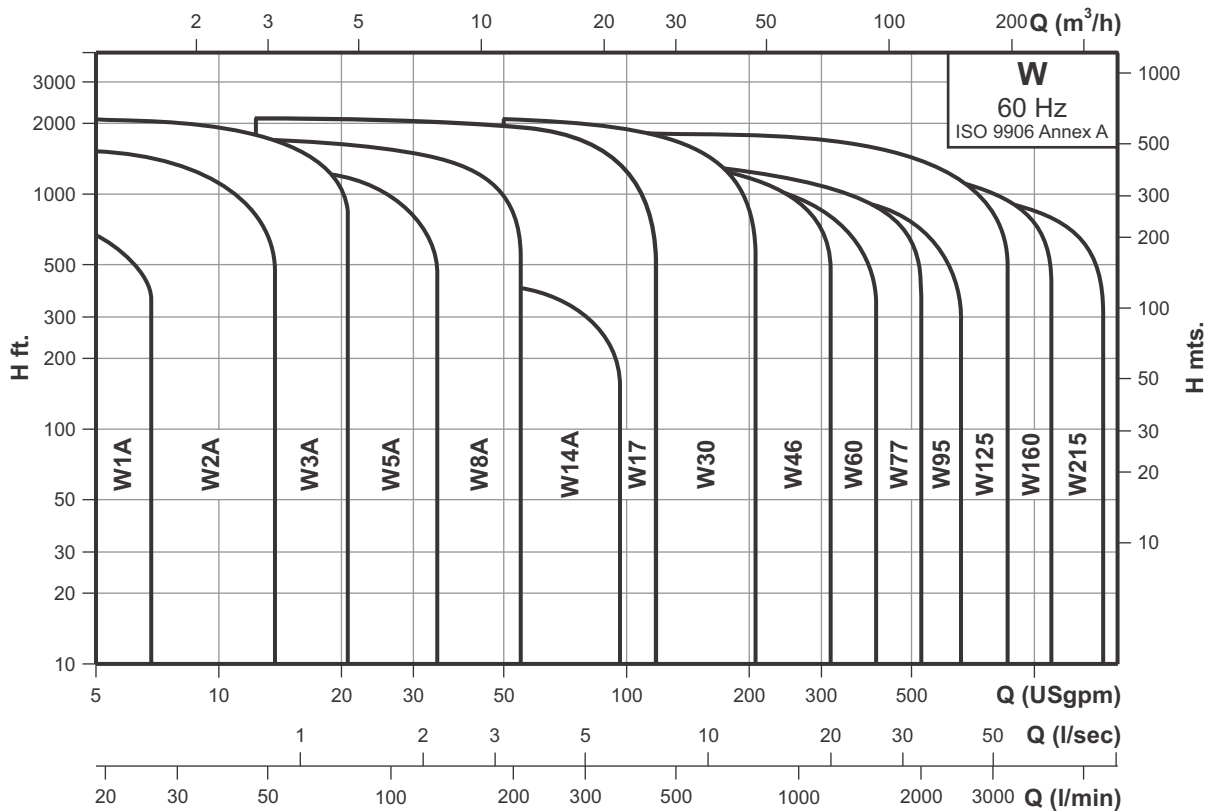
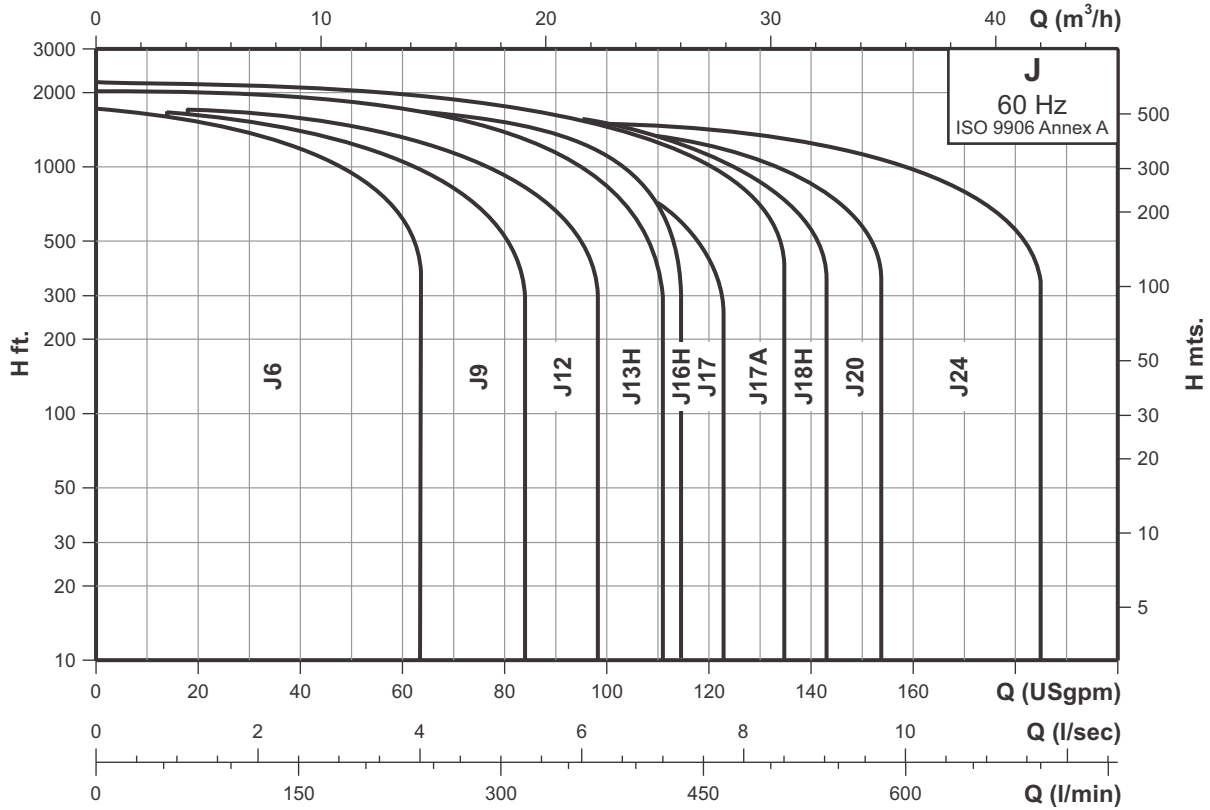

Product range

Stainless steel submersible bore well pumps

J & W

Type	Stainless steel AISI 304**	Connection*	Flange connection LUBI flange
W1A	●	Rp 1¼	
W2A	●	Rp 1¼ (Rp 2)	
W3A	●	Rp 1¼ (Rp 2)	
W5A	●	Rp 1½ (Rp 2)	
W8A	●	Rp 2 (Rp 2)	
W14A	●	Rp 2	
J6	●	Rp 2½	
J9	●	Rp 2½	
J12	●	Rp 2½	
J17	●	Rp 2½	
J17A	●	Rp 2½	
J20	●	Rp 2½	
J24	●	Rp 2½	
J13H	●	Rp 2½	
J16H	●	Rp 2½	
J18H	●	Rp 2½	
W17	●	Rp 2½ (Rp 3)	
W30	●	Rp 3 (Rp 3)	
W46	●	Rp 3/Rp 4 (Rp 3)	
W60	●	Rp 3/Rp 4	
W77	●	Rp 5	5"
W95	●	Rp 5	5"
W125	●	Rp 6	6"
W160	●	Rp 6	6"
W215	●	Rp 6	6"

Note: * Figures in brackets () indicate connection for pumps in sleeve.

** Stainless steel AISI 316 is available on request.

Features and benefits

J & W

Stainless steel submersible bore well pumps

Meeting all your water pumping needs

The Lubi J & W series range of submersible pumps comprises a large variety of models suitable for 4", 6", 8" & 10" bore well. With flow range up to 1475 USgpm and head range up to 2231 feet. There is a Lubi stainless steel pump available for every specified duty point within this range.

Material & design for wear & corrosion resistance

Submersible pumps made out of materials other than stainless steel can run very well in cold, clean & clear water. However ground water contains abrasives like sand which can quickly wear out both the pump & motor. Lubi has hence designed & developed the J & W series pumps which are made completely out of high grade stainless steel & rubber of premium quality to ensure that the suspended particles do not wear out the pump.

All Lubi J & W series pumps are made entirely of stainless steel AISI 304 (DIN W. - Nr. 1.4301). For particularly aggressive liquids pumps are available in extra high grade stainless steel AISI 316 (DIN W. - Nr. 1.4401). For handling slightly contaminated water such as oil containing water we can offer all rubber parts made of Viton® as an option.

- As shown in adjoining pie chart for a typical ground water applications the initial installation cost would work out 5%, maintenance cost over the lifespan would be another 6% and energy cost will be 89% of the total cost incurred by the customer for owning & operating the pump over its entire life span.

Minimum cost of ownership

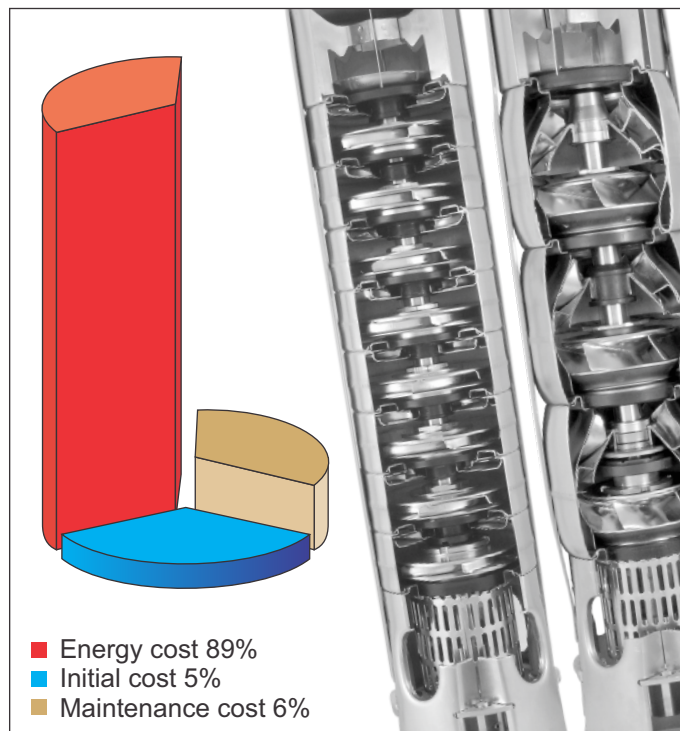

The initial cost of purchasing a pump is a fraction of the total cost of owning & operating a pump over its entire life span.

Cost of ownership is thinking about the total cost of ownership during the entire life span of the pumps. It means that you should know and ensure that energy cost and maintenance cost which contribute 95% of the total cost of ownership is brought down as much as possible. It also means the benefits of business relationship with Lubi like assistance in making the correct decision about the selection of pumps, reliability and consistency in performance over the life span of the pumps.

- Lubi's J & W series pump can help you, bring down the operating cost by offering higher pumping efficiency due to state-of-the-art hydraulic design & usage of high grade stainless steel sheet metal which offers a very low coefficient of friction which significantly reduces energy consumption. Lubi can also help you by providing expert technical advise during selection & installation of the pump. Maintenance cost is also driven down due to high reliability of the pumps and quick response to your service calls which are attended by our factory authorized service stations.

Reliable Consistent Performance

As the pumps are 100% made out of high grade stainless steel they can withstand the harsh abrasive and corrosive environment during its life span. The octagonal rubber bearings and built in sand protection shields are designed to ensure that sand is removed from the pump and motor by the water that is being pumped.



High efficiency in a brand new pump will not reduce cost of ownership if the efficiency starts to drop within a few days of installation. Erosion of seal rings and corrosion of metal parts are the main reasons that contribute for loss of performance & efficiency.

Features and benefits

J & W

Stainless steel submersible bore well pumps

Therefore the J & W series pumps are made entirely of high grade stainless steel which ensure high efficiency and low energy cost during the entire life span of the pump. In order to benefit fully from the high efficiency of Lubi J & W series pumps and motors the piping system used with the pumps should offer a very little friction loss.

Following are typical examples which show you how you can drive down the cost of ownership by installing the J & W series pumps and using the benefits of working with the installation of the pumping system.

Reduce energy cost, the best way to calculate energy cost is to measure the wire to water energy in kWh/m³ or kWh/gallon which includes losses in motor, pump, cable, pipes etc. Lubi offers the J & W series pumps with one of the highest wire to water efficiencies in the industry.

Let us compare energy cost typically between a pump manufactured by say an ordinary ABC Company against the “W” series pump manufactured by Lubi.

	ABC company	Lubi
Model	XYZ	W46
HP	40	40
kW	30	30
Stage	20	20
Head	577 feet	577 feet
Flow	198 USgpm	198 USgpm
Cost	US \$ 1300	US \$ 2260
Motor efficiency	79%	85%
Pump efficiency	60%	75%
Overall efficiency	47.5%	64%
Input power	45.43 kWh	33.72 kWh
kWh/day (For 8 hours operation)	363.44 kWh	269.76 kWh
kWh/year	132655 kWh	98462 kWh
kWh/10 year	1326550 kWh	984620 kWh
Energy cost	US \$ 165819	US \$ 123077

Saving in energy cost alone will be US \$ 42742 in the 10 years. Thus if you purchase the Lubi W46 pump then the payback period will be 82 days (less than 3 months).

Low installation costs

Stainless steel means low weight facilitating the handling of pumps and resulting in low equipment costs and reduced installation and service time. In addition pumps will be as new after service due to the high wear resistance of stainless steel.

Application assistance

Our well trained marketing team can assist you in carrying out a detailed analysis of your pumping requirement and make the correct recommendation after defining precise specifications required for your application.

Customized pumping solutions

- In case of applications where our standard range of pumps may not be suitable we can offer a number of customized solutions designed for special applications or operating conditions.

- In such cases our team of design & application engineers will understand the applications or operating conditions & work out a customized solution without compromising the high standards of performance, reliability and serviceability that we adhere to for our products.



Design features

Stainless steel submersible bore well pumps

J & W

Non-return valve

All pumps are equipped with a reliable non-return valve which prevents back flow in connection with pump stoppage.

Furthermore, the short closing time of the non-return valve means that the risk of destructive water hammer is reduced to a minimum.

The valve casing is designed for optimum hydraulic properties, to minimize the pressure loss across the valve and thus contributes to the high efficiency of the pump.

Bearings with sand channels

All bearings are water-lubricated and have a squared shape enabling sand particles, if any, to leave the pump together with the pumped liquid.

Stop ring

The stop ring prevents damage to the pump during transport and in case of up-thrust in connection with start-up.

The stop ring, which is designed as a thrust bearing, limits axial movements of the pump shaft.

The stationary part of the stop ring is secured in the upper intermediate chamber. The rotating part is fitted above the split cone.

Inlet strainer

The inlet strainer prevents particles over a certain size from entering the pump.

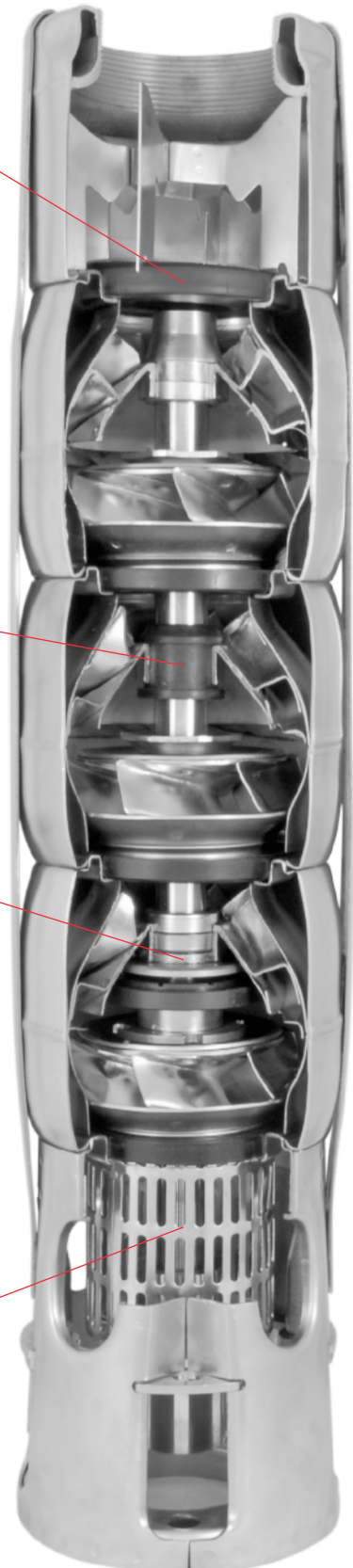

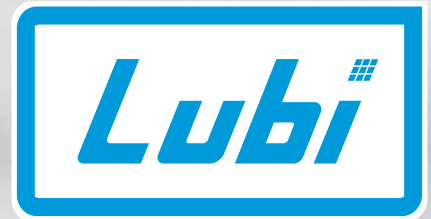

Submersible

Pumps • Motors

60Hz **4"**
Submersible Pump

Pumping Solution

Product data

4"

Stainless steel submersible bore well pumps

Construction

- Submersible motor & pumps for deep wells of 4" (DN 100 mm).
- Sized for connection to the motor according to NEMA standards.
- Delivery casing with built-in non-return valve.
- All standard pumps are completely manufactured out of stainless steel AISI 304 sheet metal.
- Impellers:**
 - Radial flow impellers**
W1A, W2A, W3A, W5A
 - Mixed flow impellers**
W8A, W14A
- Connection: Screwed pipe connection with NPT thread as standard.

Applications

- Water supply
- Irrigation
- Civil
- Industrial
- Fire fighting

Performance range

- Flow range: Max. 96.4 USgpm
- Head range: Max. 2231 feet

Operating conditions

- Liquid temperature: +32°F to +113°F
- Max. sand content into the water: 50 g/m³
- Max. starts per hour: 30 at regular intervals
- Direction of rotation: Clockwise as seen from the pump coupling side

Special construction on request

- Also available in stainless steel AISI 316 material (for sea water application).
- Also available with BSP thread pipe connection.



Construction

Stainless steel submersible bore well pumps

4"

Sectional drawing

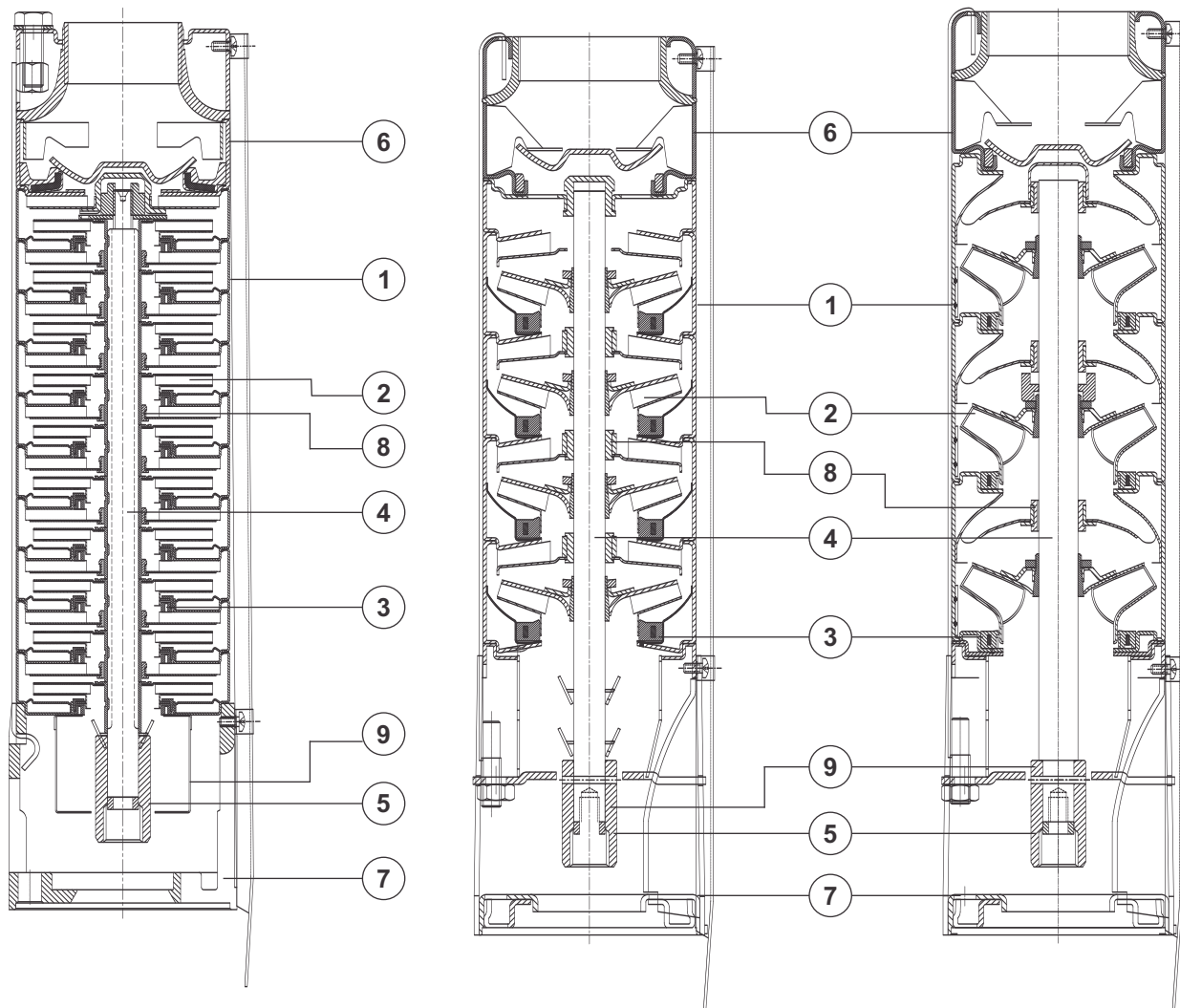

“W” type pump
W1A, W2A, W3A, W5A

“W” type pump
W8A

“W” type pump
W14A

Materials

Pos.	Component	Material
1	Bowl / Diffuser	Stainless steel AISI 304
2	Impeller	Stainless steel AISI 304
3	Neck ring	NBR
4	Shaft	Stainless steel AISI 316
5	Couple	Stainless steel AISI 316
6	Delivery casing	Stainless steel AISI 304
7	Suction case	Stainless steel AISI 304
8	Bearing bush	NBR
9	Strainer	Stainless steel AISI 304

Technical data

Radial flow 4" stainless steel submersible bore well pumps

W1A

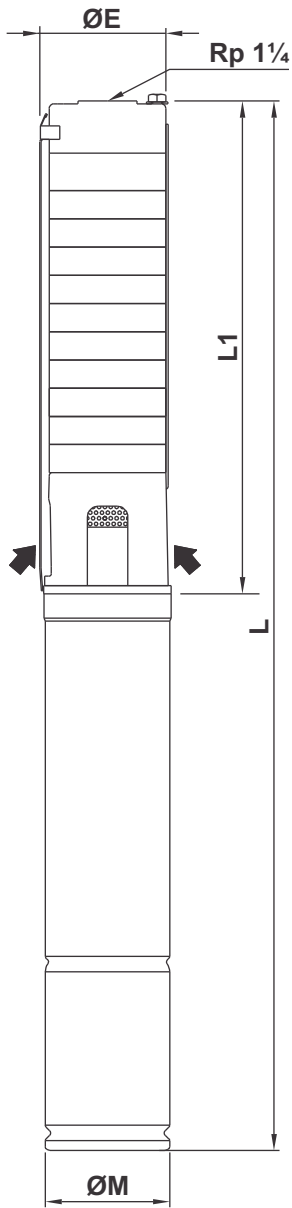

Performance chart

Pump type	Motor type		HP	kW	Q l/min USgpm	n = 3450 rpm					
	Oil filled	Water filled				0	7	10	13.3	20	25.8
						0	1.8	2.6	3.5	5.3	6.8
W1A/9	H4605	L4605	0.50	0.37	H ft.	253	240	230	213	171	115
W1A/13	H4605	L4605	0.50	0.37		359	344	326	303	238	156
W1A/18	H4607	L4607	0.75	0.55		499	476	451	418	328	217
W1A/22	H4610	L4610	1.00	0.75		610	581	553	515	402	267
W1A/26	H4615	L4615	1.50	1.10		727	692	659	614	489	328
W1A/31	H4615	L4615	1.50	1.10		814	779	735	673	509	335
W1A/39	H4620	L4620	2.00	1.50		1017	974	915	837	630	410

Dimensions & weights of pump with Oil filled motor

Type Pump + Motor	ØM [inch]	ØE [inch]	Length [inch]			Gross weight [lbs]			Gross volume [ft³]		
			L1	L		Pump	Pump+Motor		Pump	Pump+Motor	
				1 ~	3 ~		1 ~	3 ~		1 ~	3 ~
W1A/9 + H4605	3.74	3.98	13.54	28.70	28.31	9	31	31	0.2	0.5	0.5
W1A/13 + H4605	3.74	3.98	16.85	32.01	31.61	12	34	34	0.4	0.7	0.7
W1A/18 + H4607	3.74	3.98	20.98	37.13	36.54	14	39	37	0.4	0.7	0.7
W1A/22 + H4610	3.74	3.98	24.29	41.02	40.43	17	44	41	0.4	0.7	0.7
W1A/26 + H4615	3.74	3.98	27.60	45.91	44.33	19	49	45	0.4	0.7	0.7
W1A/31 + H4615	3.74	3.98	33.50	51.81	50.24	21	51	48	0.4	0.7	0.7
W1A/39 + H4620	3.74	3.98	40.12	60.00	58.43	25	59	57	0.6	1.0	0.9

Dimensions & weights of pump with Water filled motor

Type Pump + Motor	ØM [inch]	ØE [inch]	Length [inch]			Gross weight [lbs]			Gross volume [ft³]		
			L1	L		Pump	Pump+Motor		Pump	Pump+Motor	
				1 ~	3 ~		1 ~	3 ~		1 ~	3 ~
W1A/09 + L4605	3.74	3.98	13.54	30.51	30.91	9	41	44	0.2	0.5	0.5
W1A/13 + L4605	3.74	3.98	16.85	33.82	34.21	12	44	47	0.4	0.7	0.7
W1A/18 + L4607	3.74	3.98	20.98	38.54	38.94	14	48	51	0.4	0.7	0.7
W1A/22 + L4610	3.74	3.98	24.29	42.24	42.83	17	54	56	0.4	0.7	0.7
W1A/26 + L4615	3.74	3.98	27.60	47.72	48.11	19	61	64	0.4	0.7	0.8
W1A/31 + L4615	3.74	3.98	33.50	53.62	54.02	21	63	66	0.4	0.7	0.8
W1A/39 + L4620	3.74	3.98	40.12	64.17	62.60	25	75	75	0.6	1.0	1.0

Note: ØE = For single cable motor maximum diameter of pump inclusive of cable guard.
 Add -T subscript to motor type for 4" Oil filled and Water filled 3 ~ motor.
 All dimensions in inches unless otherwise noted.

Performance curves

Radial flow 4" stainless steel submersible bore well pumps

W1A

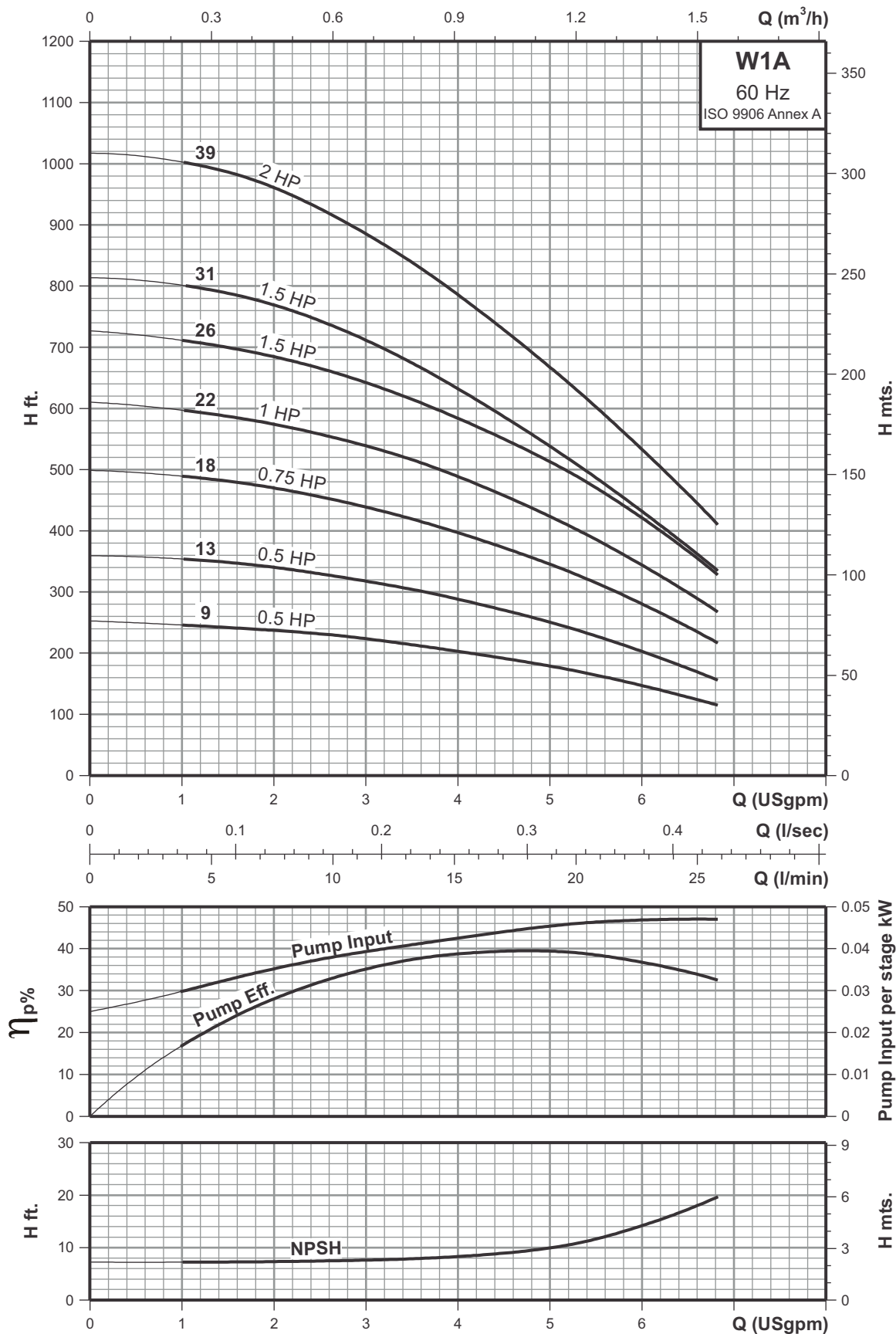

Technical data

Radial flow 4" stainless steel submersible bore well pumps

W2A

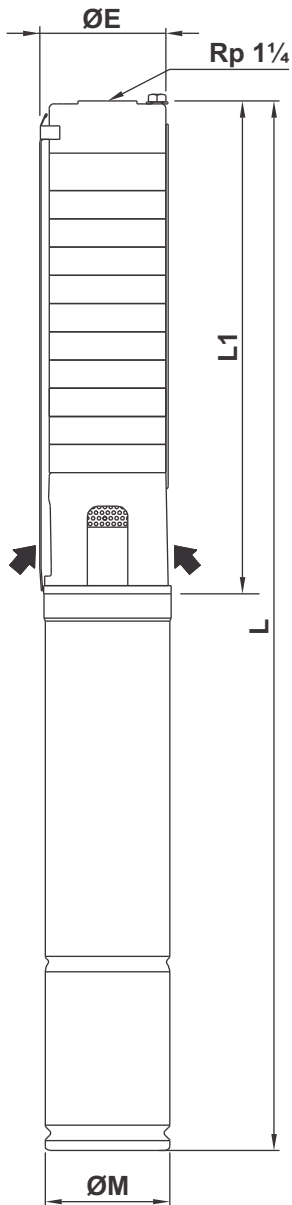

W2A/58 is mounted in sleeve for Rp 2 connection.

Performance chart

Pump type	Motor type		HP	kW	Q l/min USgpm	n = 3450 rpm					
	Oil filled	Water filled				0	7	20	33.3	40	52
						0	1.8	5.3	8.8	10.6	13.7
W2A/6	H4605	L4605	0.50	0.37	H ft.	169	166	154	131	115	62
W2A/9	H4605	L4605	0.50	0.37		254	249	230	194	164	89
W2A/12	H4607	L4607	0.75	0.55		338	331	308	259	220	116
W2A/15	H4610	L4610	1.00	0.75		422	418	384	325	277	148
W2A/21	H4615	L4615	1.50	1.10		591	584	538	456	389	203
W2A/27	H4620	L4620	2.00	1.50		756	748	686	577	492	258
W2A/34	H4630	L4630	3.00	2.20		981	961	879	738	623	315
W2A/48	H4655	L4655	5.50	4.00		1391	1365	1260	1060	902	468
W2A/58	H4655	L4655	5.50	4.00		1673	1640	1504	1263	1066	541

Dimensions & weights of pump with Oil filled motor

Type Pump + Motor	ØM [inch]	ØE [inch]	Length [inch]			Gross weight [lbs]			Gross volume [ft³]		
			L1	L		Pump	Pump+Motor		Pump	Pump+Motor	
				1 ~	3 ~		1 ~	3 ~		1 ~	3 ~
W2A/6 + H4605	3.74	3.98	11.06	26.22	25.83	7	30	29	0.2	0.5	0.5
W2A/9 + H4605	3.74	3.98	13.54	28.70	28.31	9	31	31	0.2	0.5	0.5
W2A/12 + H4607	3.74	3.98	16.02	32.17	31.57	11	35	34	0.2	0.5	0.5
W2A/15 + H4610	3.74	3.98	18.50	35.24	34.65	13	39	37	0.4	0.7	0.7
W2A/21 + H4615	3.74	3.98	23.46	41.77	40.20	16	45	42	0.4	0.7	0.7
W2A/27 + H4620	3.74	3.98	28.43	48.31	46.73	19	54	52	0.4	0.8	0.7
W2A/34 + H4630	3.74	3.98	35.98	58.23	55.87	22	67	58	0.4	0.8	0.8
W2A/48 + H4655	3.74	3.98	47.56	73.74	71.77	29	79	76	0.6	1.1	1.0
W2A/58 + H4655	3.74	4.25	62.87	89.06	87.09	34	84	81	0.6	1.1	1.0

Dimensions & weights of pump with Water filled motor

Type Pump + Motor	ØM [inch]	ØE [inch]	Length [inch]			Gross weight [lbs]			Gross volume [ft³]		
			L1	L		Pump	Pump+Motor		Pump	Pump+Motor	
				1 ~	3 ~		1 ~	3 ~		1 ~	3 ~
W2A/06 + L4605	3.74	3.98	11.06	28.03	28.43	7	39	43	0.2	0.5	0.5
W2A/09 + L4605	3.74	3.98	13.54	30.51	30.91	9	41	44	0.2	0.5	0.5
W2A/12 + L4607	3.74	3.98	16.02	33.58	33.98	11	45	48	0.2	0.5	0.5
W2A/15 + L4610	3.74	3.98	18.50	36.46	37.05	13	50	52	0.4	0.7	0.7
W2A/21 + L4615	3.74	3.98	23.46	43.58	43.98	16	58	60	0.4	0.7	0.8
W2A/27 + L4620	3.74	3.98	28.43	52.48	50.91	19	69	69	0.4	0.8	0.8
W2A/34 + L4630	3.74	3.98	35.98	63.98	62.40	22	81	79	0.4	0.9	0.9
W2A/48 + L4655	3.74	3.98	47.56	80.67	79.88	29	96	103	0.6	1.1	1.1
W2A/58 + L4655	3.74	4.25	62.87	95.98	95.20	34	101	108	0.6	1.1	1.1

Note: ØE = For single cable motor maximum diameter of pump inclusive of cable guard.
Add -T subscript to motor type for 4" Oil filled and Water filled 3 ~ motor.
All dimensions in inches unless otherwise noted.

Performance curves

Radial flow 4" stainless steel submersible bore well pumps

W2A

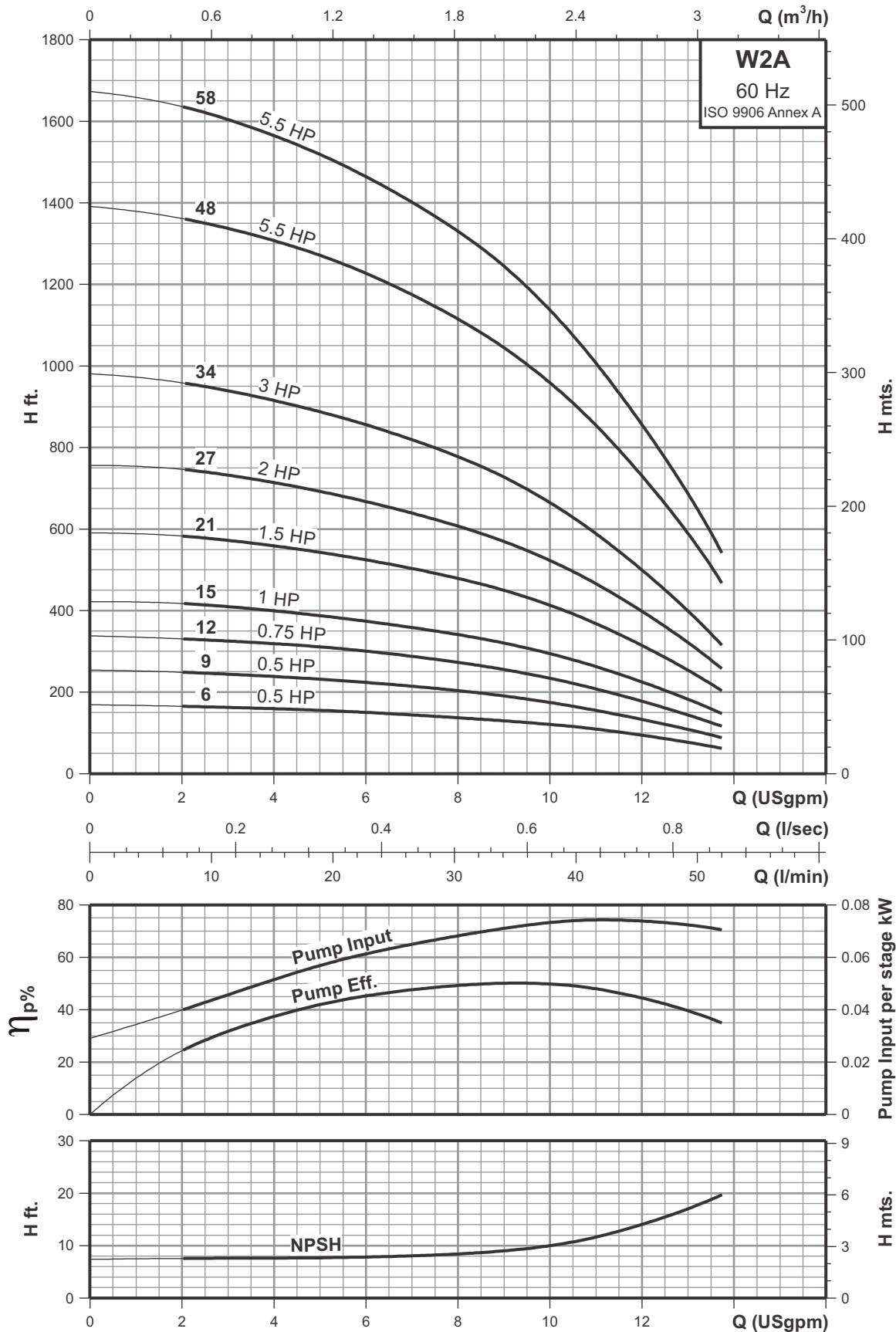

Technical data

Radial flow 4" stainless steel submersible bore well pumps

W3A

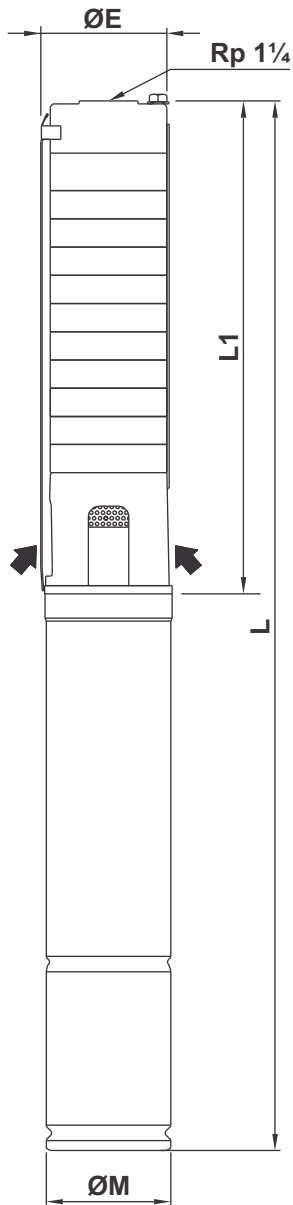

W3A/75 is mounted in sleeve for Rp 2 connection.

Performance chart

Pump type	Motor type		HP	kW	Q l/min USgpm	n = 3450 rpm					
	Oil filled	Water filled				0	20	33.3	46.7	60	78.4
						0	5.3	8.8	12.3	15.9	20.7
W3A/5	H4605	L4605	0.50	0.37	H ft.	151	138	131	125	105	67
W3A/8	H4607	L4607	0.75	0.55		238	225	208	195	164	108
W3A/10	H4610	L4610	1.00	0.75		299	276	262	240	207	133
W3A/14	H4615	L4615	1.50	1.10		420	392	367	335	294	194
W3A/18	H4620	L4620	2.00	1.50		535	495	469	427	367	236
W3A/24	H4630	L4630	3.00	2.20		719	666	627	577	492	325
W3A/32	H4640	L4640	4.00	3.00		951	886	846	786	689	490
W3A/38	H4655	L4655	5.50	4.00		1132	1060	1010	942	830	591
W3A/56	H4675	L4675	7.50	5.50		1668	1560	1483	1381	1217	869
W3A/75	H46100	L6610-KP	10.0	7.50		2231	2080	1980	1837	1621	1148

Dimensions & weights of pump with Oil filled motor

Type Pump + Motor	ØM [inch]	ØE [inch]	Length [inch]			Gross weight [lbs]			Gross volume [ft³]		
			L1	L		Pump	Pump+Motor		Pump	Pump+Motor	
				1 ~	3 ~		1 ~	3 ~		1 ~	3 ~
W3A/5 + H4605	3.74	3.98	10.24	25.39	25.00	7	29	29	0.2	0.5	0.5
W3A/8 + H4607	3.74	3.98	12.72	28.86	28.27	8	33	32	0.2	0.5	0.5
W3A/10 + H4610	3.74	3.98	14.37	31.10	30.51	10	37	34	0.2	0.5	0.5
W3A/14 + H4615	3.74	3.98	17.68	35.98	34.41	13	42	39	0.4	0.7	0.7
W3A/18 + H4620	3.74	3.98	20.98	40.87	39.29	14	49	47	0.4	0.8	0.7
W3A/24 + H4630	3.74	3.98	25.94	48.19	45.83	18	62	54	0.4	0.8	0.8
W3A/32 + H4640	3.74	3.98	34.33	-	56.57	22	-	64	0.4	-	0.8
W3A/38 + H4655	3.74	3.98	39.29	65.47	63.50	25	74	72	0.6	1.1	1.0
W3A/56 + H4675	3.74	3.98	68.78	-	94.96	33	-	88	0.6	-	1.1
W3A/75 + H46100	3.74	4.25	82.01	-	113.70	47	-	117	0.7	-	1.2

Dimensions & weights of pump with Water filled motor

Type Pump + Motor	ØM [inch]	ØE [inch]	Length [inch]			Gross weight [lbs]			Gross volume [ft³]		
			L1	L		Pump	Pump+Motor		Pump	Pump+Motor	
				1 ~	3 ~		1 ~	3 ~		1 ~	3 ~
W3A/05 + L4605	3.74	3.98	10.24	27.20	27.60	7	39	42	0.2	0.5	0.5
W3A/08 + L4607	3.74	3.98	12.72	30.28	30.67	8	42	45	0.2	0.5	0.5
W3A/10 + L4610	3.74	3.98	14.37	32.32	32.91	10	47	49	0.2	0.5	0.5
W3A/14 + L4615	3.74	3.98	17.68	37.80	38.19	13	55	57	0.4	0.7	0.8
W3A/18 + L4620	3.74	3.98	20.98	45.04	43.46	14	64	64	0.4	0.8	0.8
W3A/24 + L4630	3.74	3.98	25.94	53.94	52.36	18	76	74	0.4	0.9	0.9
W3A/32 + L4640	3.74	3.98	34.33	-	62.72	22	-	83	0.4	-	0.9
W3A/38 + L4655	3.74	3.98	39.29	72.40	71.61	25	91	98	0.6	1.1	1.1
W3A/56 + L4675	3.74	3.98	68.78	-	103.86	33	-	109	0.6	-	1.1
W3A/75 + L6610-KP	5.59	5.59	84.49	-	112.36	47	-	167	0.7	-	1.6

Note: ØE = For single cable motor maximum diameter of pump inclusive of cable guard.
Add -T subscript to motor type for 4" Oil filled and Water filled 3 ~ motor.
All dimensions in inches unless otherwise noted.

Performance curves

Radial flow 4" stainless steel submersible bore well pumps

W3A

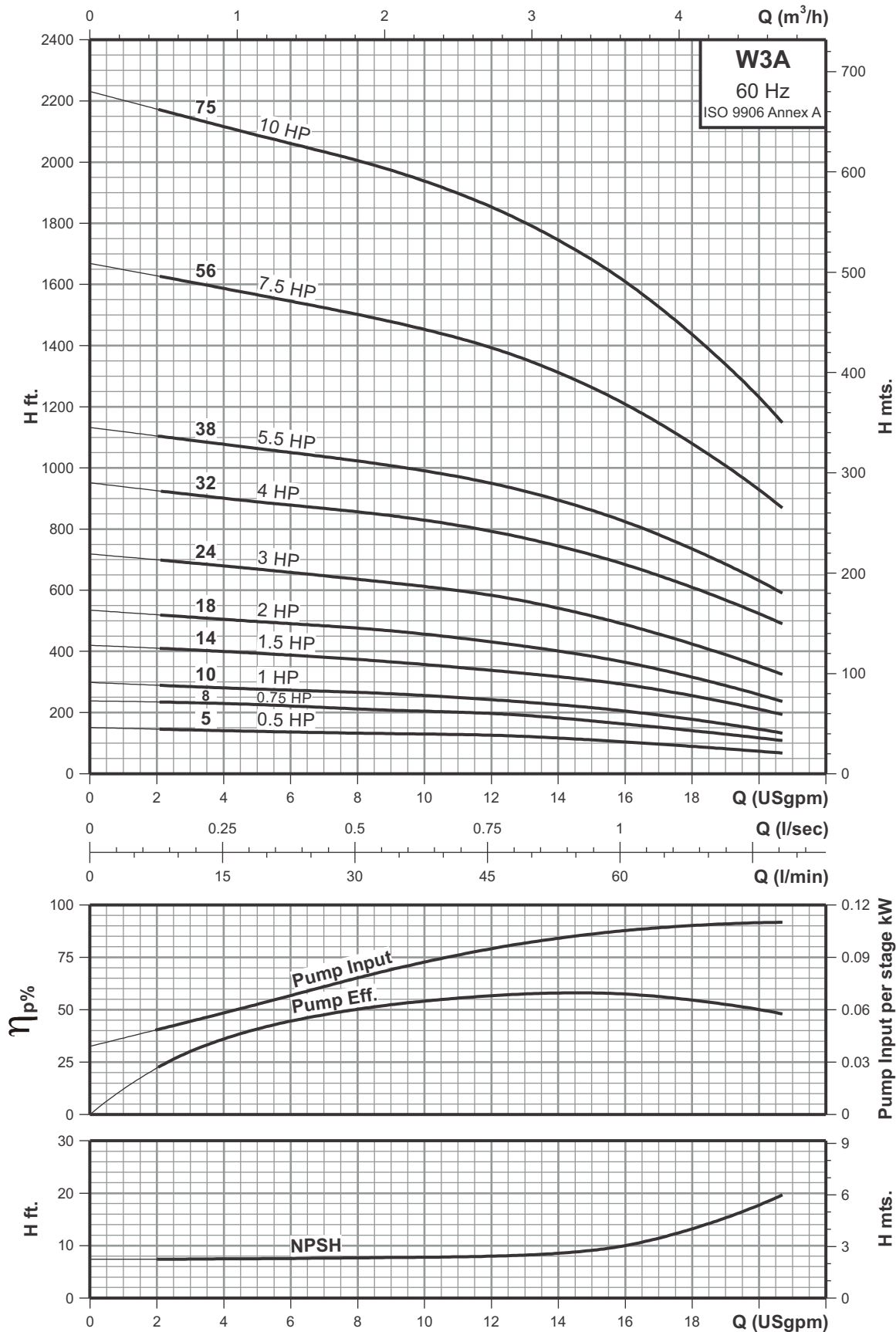

Technical data

Radial flow 4" stainless steel submersible bore well pumps

W5A

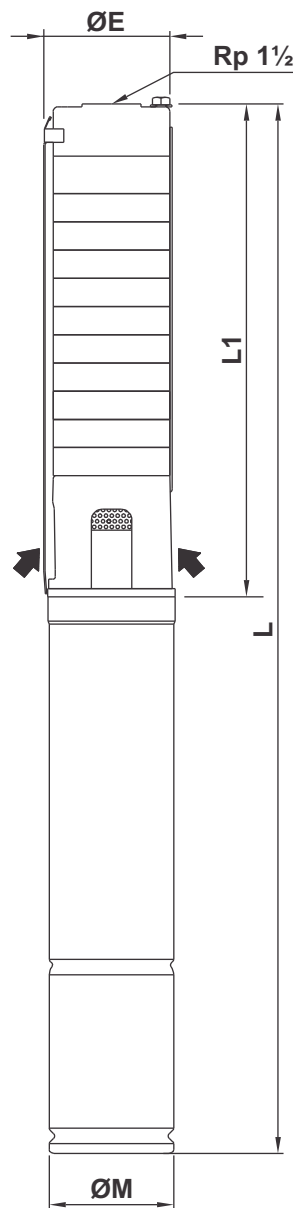

W5A/52 is mounted in sleeve for Rp 2 connection.

Performance chart

Pump type	Motor type		HP	kW	Q l/min USgpm	n = 3450 rpm					
	Oil filled	Water filled				0	40	66.7	93.4	106.7	130.1
						0	10.6	17.6	24.7	28.2	34.4
W5A/3	H4605	L4605	0.50	0.37	H ft.	92	79	74	64	56	33
W5A/5	H4607	L4607	0.75	0.55		151	131	123	102	90	57
W5A/7	H4610	L4610	1.00	0.75		210	187	169	141	123	75
W5A/9	H4615	L4615	1.50	1.10		272	240	220	187	161	98
W5A/11	H4620	L4620	2.00	1.50		331	295	262	223	194	121
W5A/15	H4630	L4630	3.00	2.20		456	399	363	308	262	164
W5A/21	H4640	L4640	4.00	3.00		636	558	509	427	367	230
W5A/26	H4655	L4655	5.50	4.00		789	692	633	533	459	290
W5A/39	H4675	L4675	7.50	5.50		1183	1037	945	797	689	427
W5A/52	H46100	L6610-KP	10.0	7.50		1575	1378	1253	1050	906	558

Dimensions & weights of pump with Oil filled motor

Type Pump + Motor	ØM [inch]	ØE [inch]	Length [inch]			Gross weight [lbs]			Gross volume [ft ³]		
			L1	L		Pump	Pump+Motor		Pump	Pump+Motor	
				1 ~	3 ~		1 ~	3 ~		1 ~	3 ~
W5A/3 + H4605	3.74	3.98	8.62	23.78	23.39	6	28	28	0.2	0.5	0.5
W5A/5 + H4607	3.74	3.98	10.28	26.42	25.83	7	31	30	0.2	0.5	0.5
W5A/7 + H4610	3.74	3.98	11.93	28.66	28.07	8	34	32	0.2	0.5	0.5
W5A/9 + H4615	3.74	3.98	13.58	31.89	30.31	9	39	35	0.2	0.5	0.5
W5A/11 + H4620	3.74	3.98	15.24	35.12	33.54	11	45	43	0.2	0.6	0.5
W5A/15 + H4630	3.74	3.98	18.54	40.79	38.43	13	57	49	0.4	0.8	0.8
W5A/21 + H4640	3.74	3.98	23.50	-	45.75	16	-	58	0.4	-	0.8
W5A/26 + H4655	3.74	3.98	27.64	53.82	51.85	19	69	66	0.4	0.9	0.8
W5A/39 + H4675	3.74	3.98	40.12	-	66.30	25	-	80	0.6	-	1.1
W5A/52 + H46100	3.74	4.25	62.99	-	94.69	31	-	101	0.6	-	1.1

Dimensions & weights of pump with Water filled motor

Type Pump + Motor	ØM [inch]	ØE [inch]	Length [inch]			Gross weight [lbs]			Gross volume [ft ³]		
			L1	L		Pump	Pump+Motor		Pump	Pump+Motor	
				1 ~	3 ~		1 ~	3 ~		1 ~	3 ~
W5A/03 + L4605	3.74	3.98	8.62	25.59	25.98	6	37	41	0.2	0.5	0.5
W5A/05 + L4607	3.74	3.98	10.28	27.83	28.23	7	41	44	0.2	0.5	0.5
W5A/07 + L4610	3.74	3.98	11.93	29.88	30.47	8	45	47	0.2	0.5	0.5
W5A/09 + L4615	3.74	3.98	13.58	33.70	34.09	9	51	54	0.2	0.5	0.6
W5A/11 + L4620	3.74	3.98	15.24	39.29	37.72	11	60	60	0.2	0.6	0.6
W5A/15 + L4630	3.74	3.98	18.54	46.54	44.96	13	71	69	0.4	0.9	0.9
W5A/21 + L4640	3.74	3.98	23.50	-	51.89	16	-	77	0.4	-	0.9
W5A/26 + L4655	3.74	3.98	27.64	60.75	59.96	19	86	93	0.4	0.9	0.9
W5A/39 + L4675	3.74	3.98	40.12	-	75.20	25	-	101	0.6	-	1.1
W5A/52 + L6610-KP	5.59	5.59	65.47	-	93.35	31	-	150	0.6	-	1.5

Note: ØE = For single cable motor maximum diameter of pump inclusive of cable guard.
Add -T subscript to motor type for 4" Oil filled and Water filled 3 ~ motor.
All dimensions in inches unless otherwise noted.

Performance curves

Radial flow 4" stainless steel submersible bore well pumps

W5A

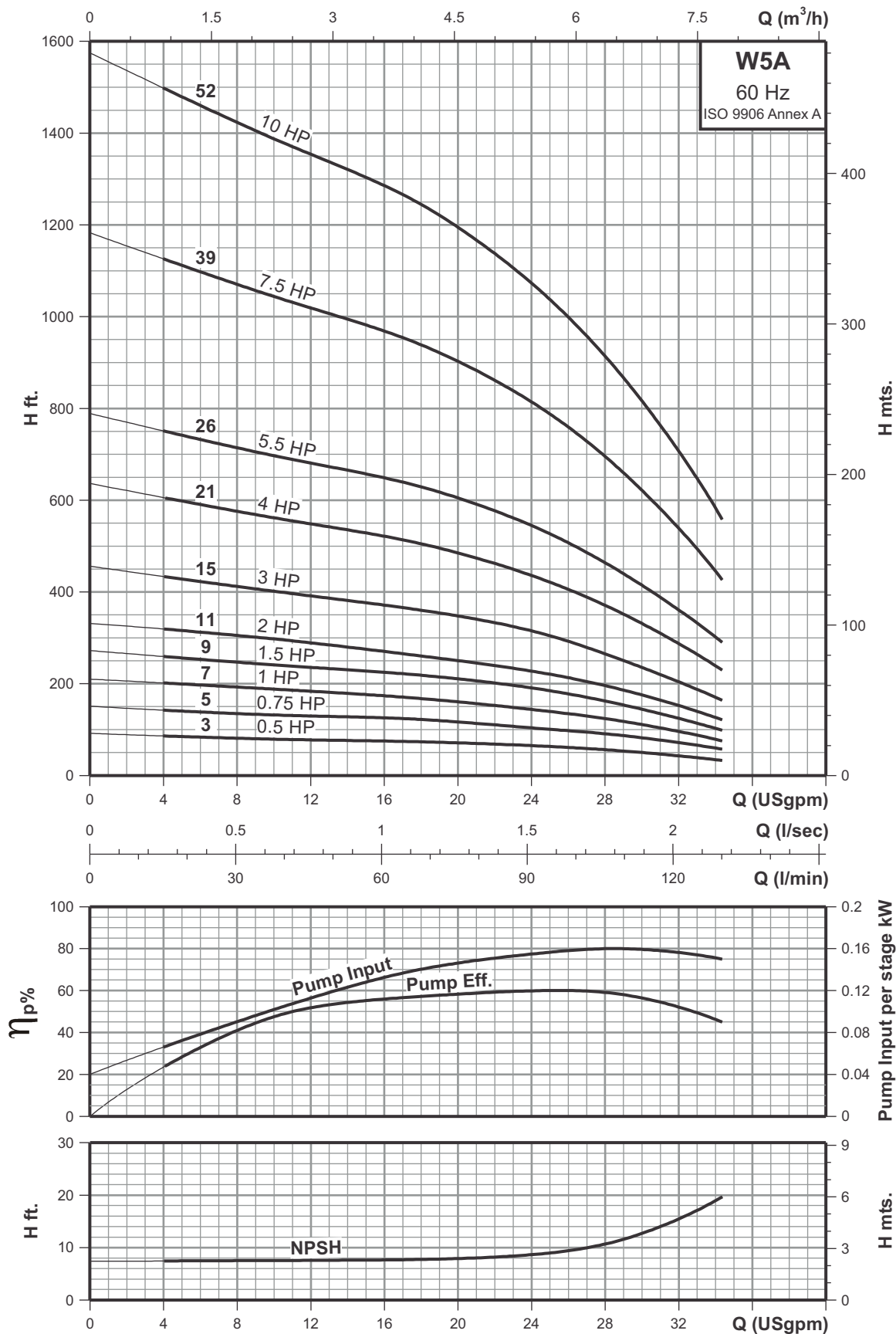

Technical data

Mixed flow 4" stainless steel submersible bore well pumps

W8A

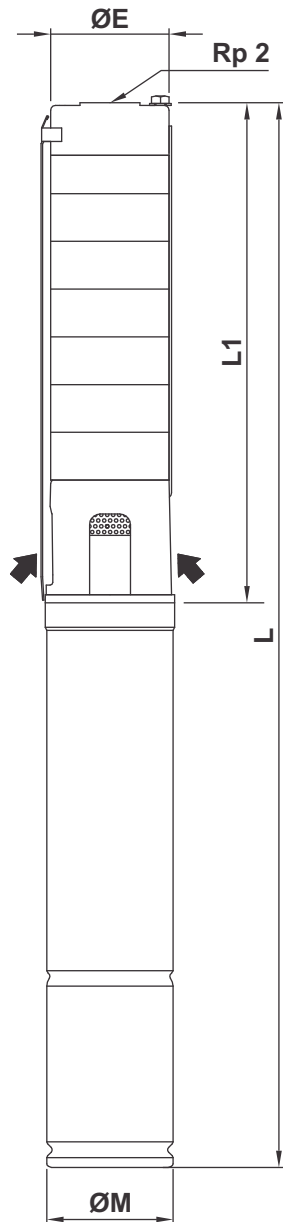

W8A/58 to W8A/66 are mounted in sleeve for Rp 2 connection.

Performance chart

Pump type	Motor type		HP	kW	Q l/min USgpm	n = 3450 rpm					
	Oil filled	Water filled				0	50	100	150	183	208
						0	13.2	26.4	39.6	48.3	54.9
W8A/3	H4607	L4607	0.75	0.55	H ft.	85	75	67	64	52	39
W8A/5	H4615	L4615	1.50	1.10		141	131	118	105	92	69
W8A/7	H4620	L4620	2.00	1.50		198	180	164	143	125	97
W8A/9	H4630	L4630	3.00	2.20		256	230	207	190	161	128
W8A/12	H4640	L4640	4.00	3.00		341	312	276	249	210	166
W8A/15	H4655	L4655	5.50	4.00		428	389	348	312	262	213
W8A/18	H4675	L4675	7.50	5.50		513	466	423	377	325	261
W8A/21	H4675	L4675	7.50	5.50		597	548	489	436	371	295
W8A/25	H4675	L4675	7.50	5.50		709	643	574	512	433	344
W8A/30	H46100	L6610-KP	10.0	7.50		853	771	689	620	525	417
W8A/37	-	L6612-KP	12.5	9.30		1050	945	843	738	623	487
W8A/44	-	L6615-KP	15.0	11.0		1247	1125	1001	884	738	577
W8A/50	-	L6617-KP	17.5	13.0		1417	1280	1145	1007	850	663
W8A/58	-	L6620-KP	20.0	15.0		1647	1490	1325	1171	984	771
W8A/66	-	L6620-KP	20.0	15.0		1867	1686	1503	1316	1099	863

Dimensions & weights of pump with Oil filled motor

Type Pump + Motor	ØM [inch]	ØE [inch]	Length [inch]			Gross weight [lbs]			Gross volume [ft³]		
			L1	L		Pump	Pump+Motor		Pump	Pump+Motor	
				1 ~	3 ~		1 ~	3 ~		1 ~	3 ~
W8A/3 + H4607	3.74	3.98	12.80	28.94	28.35	7	31	30	0.2	0.5	0.5
W8A/5 + H4615	3.74	3.98	16.10	34.41	32.83	9	38	35	0.2	0.5	0.5
W8A/7 + H4620	3.74	3.98	19.41	39.29	37.72	11	46	44	0.4	0.8	0.7
W8A/9 + H4630	3.74	3.98	22.72	44.96	42.60	14	58	49	0.4	0.8	0.8
W8A/12 + H4640	3.74	3.98	27.68	-	49.92	17	-	60	0.4	-	0.8
W8A/15 + H4655	3.74	3.98	32.64	58.82	56.85	20	70	67	0.4	0.9	0.8
W8A/18 + H4675	3.74	3.98	37.60	-	63.78	24	-	78	0.4	-	0.9
W8A/21 + H4675	3.74	3.98	42.56	-	68.74	27	-	82	0.6	-	1.1
W8A/25 + H4675	3.74	3.98	49.17	-	75.35	32	-	86	0.6	-	1.1
W8A/30 + H46100	3.74	3.98	57.44	-	89.13	37	-	107	0.6	-	1.1

Dimensions & weights of pump with Water filled motor

Type Pump + Motor	ØM [inch]	ØE [inch]	Length [inch]			Gross weight [lbs]			Gross volume [ft³]		
			L1	L		Pump	Pump+Motor		Pump	Pump+Motor	
				1 ~	3 ~		1 ~	3 ~		1 ~	3 ~
W8A/03 + L4607	3.74	3.98	12.80	30.35	30.75	7	40	44	0.2	0.5	0.5
W8A/05 + L4615	3.74	3.98	16.10	36.22	36.61	9	51	54	0.2	0.5	0.6
W8A/07 + L4620	3.74	3.98	19.41	43.46	41.89	11	61	61	0.4	0.8	0.8
W8A/09 + L4630	3.74	3.98	22.72	50.71	49.13	14	72	70	0.4	0.9	0.9
W8A/12 + L4640	3.74	3.98	27.68	-	56.06	17	-	79	0.4	-	0.9
W8A/15 + L4655	3.74	3.98	32.64	65.75	64.96	20	87	94	0.4	0.9	0.9
W8A/18 + L4675	3.74	3.98	37.60	-	72.68	24	-	99	0.4	-	0.9
W8A/21 + L4675	3.74	3.98	42.56	-	77.64	27	-	103	0.6	-	1.1
W8A/25 + L4675	3.74	3.98	49.17	-	84.25	32	-	107	0.6	-	1.1
W8A/30 + L6610-KP	5.59	5.59	59.88	-	87.76	37	-	157	0.6	-	1.5
W8A/37 + L6612-KP	5.59	5.59	71.46	-	101.30	46	-	177	0.7	-	1.6
W8A/44 + L6615-KP	5.59	5.59	83.03	-	114.45	59	-	239	6.2	-	7.3
W8A/50 + L6617-KP	5.59	5.59	105.39	-	138.19	119	-	269	6.5	-	7.6
W8A/58 + L6620-KP	5.59	5.59	118.62	-	152.60	145	-	300	6.9	-	8.0
W8A/66 + L6620-KP	5.59	5.59	131.85	-	165.83	172	-	327	7.3	-	8.4

Note: ØE = For single cable motor maximum diameter of pump inclusive of cable guard.
Add -T subscript to motor type for 4" Oil filled and Water filled 3 ~ motor.
All dimensions in inches unless otherwise noted.

Performance curves

Mixed flow 4" stainless steel submersible bore well pumps

W8A

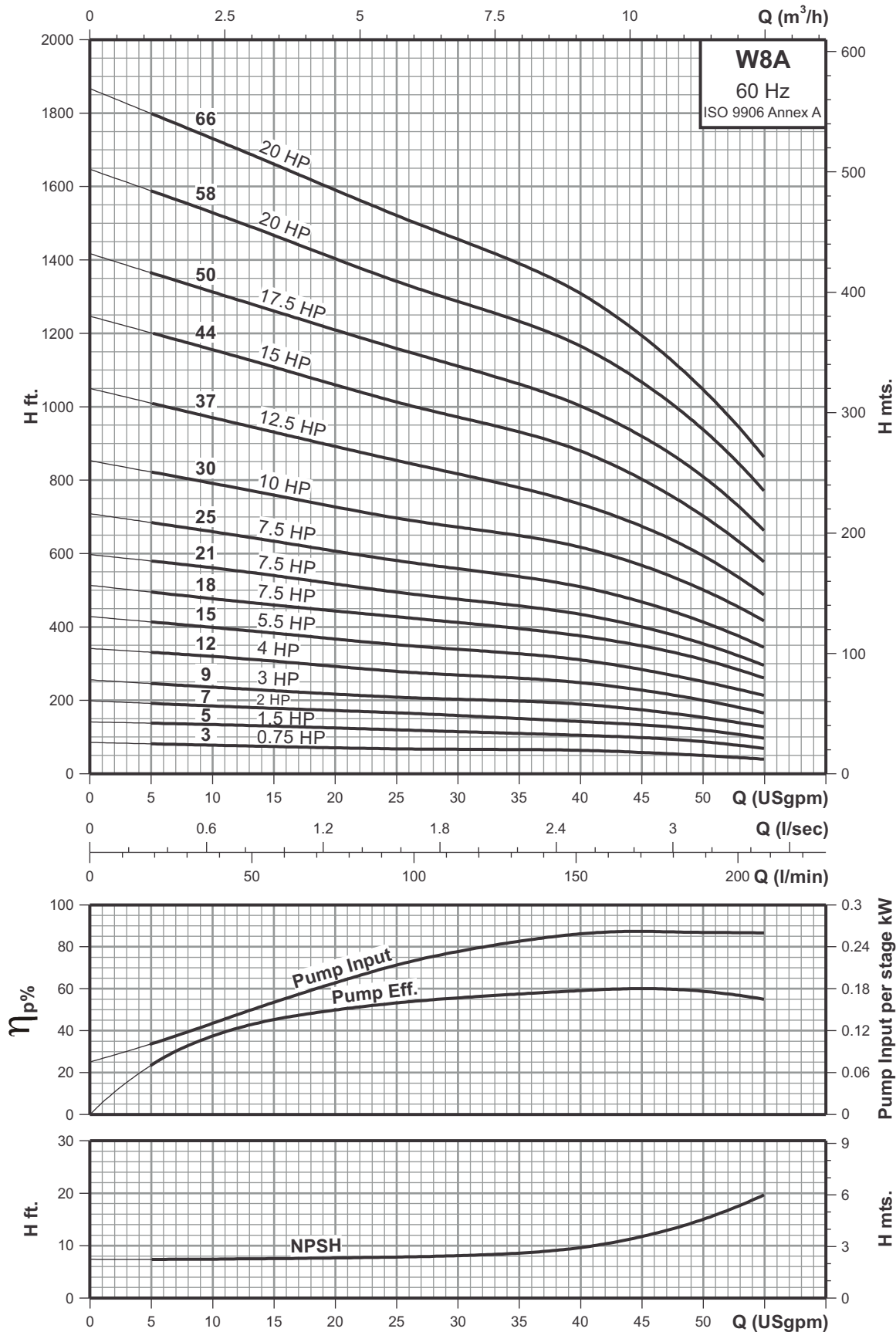

Technical data

Mixed flow 4" stainless steel submersible bore well pumps

W14A

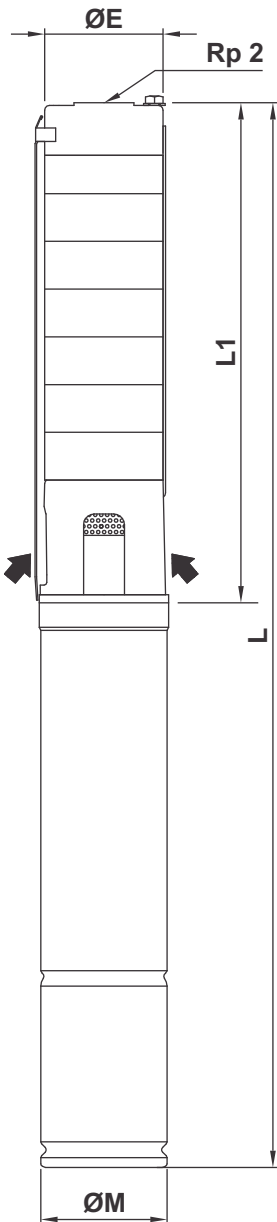

Performance chart

Pump type	Motor type		HP	kW	Q l/min USgpm	n = 3450 rpm					
	Oil filled	Water filled				0	33.3	166.7	233.4	300.1	365
						0	8.8	44	61.7	79.3	96.4
W14A/3	H4620	L4620	2.00	1.50	H ft.	94	98	85	76	62	43
W14A/5	H4630	L4630	3.00	2.20		157	161	141	125	102	70
W14A/8	H4655	L4655	5.50	4.00		250	258	226	203	164	114
W14A/12	H4675	L4675	7.50	5.50		374	387	338	302	244	169
W14A/16	H46100	L6610-KP	10.0	7.50		489	502	430	377	300	197

Dimensions & weights of pump with Oil filled motor

Type Pump + Motor	ØM [inch]	ØE [inch]	Length [inch]			Gross weight [lbs]			Gross volume [ft³]		
			L1	L		Pump	Pump+Motor		Pump	Pump+Motor	
				1 ~	3 ~		1 ~	3 ~		1 ~	3 ~
W14A/3 + H4620	3.74	3.98	14.96	34.84	33.27	10	44	42	0.2	0.6	0.5
W14A/5 + H4630	3.74	3.98	20.08	42.32	39.96	14	58	50	0.4	0.8	0.8
W14A/8 + H4655	3.74	3.98	27.76	53.94	51.97	19	68	66	0.4	0.9	0.8
W14A/12 + H4675	3.74	3.98	37.99	-	64.17	26	-	81	0.6	-	1.1
W14A/16 + H46100	3.74	3.98	40.43	-	72.13	33	-	102	0.6	-	1.1

Dimensions & weights of pump with Water filled motor

Type Pump + Motor	ØM [inch]	ØE [inch]	Length [inch]			Gross weight [lbs]			Gross volume [ft³]		
			L1	L		Pump	Pump+Motor		Pump	Pump+Motor	
				1 ~	3 ~		1 ~	3 ~		1 ~	3 ~
W14A/03 + L4620	3.74	3.98	14.96	39.02	37.44	10	60	60	0.2	0.6	0.6
W14A/05 + L4630	3.74	3.98	20.08	48.07	46.50	14	72	70	0.4	0.9	0.9
W14A/08 + L4655	3.74	3.98	27.76	60.87	60.08	19	86	92	0.4	0.9	0.9
W14A/12 + L4675	3.74	3.98	37.99	-	73.07	26	-	102	0.6	-	1.1
W14A/16 + L6610-KP	5.59	5.59	50.67	-	78.54	33	-	152	0.6	-	1.5

Note: ØE = For single cable motor maximum diameter of pump inclusive of cable guard.
 Add -T subscript to motor type for 4" Oil filled and Water filled 3 ~ motor.
 All dimensions in inches unless otherwise noted.

Performance curves

Mixed flow 4" stainless steel submersible bore well pumps

W14A

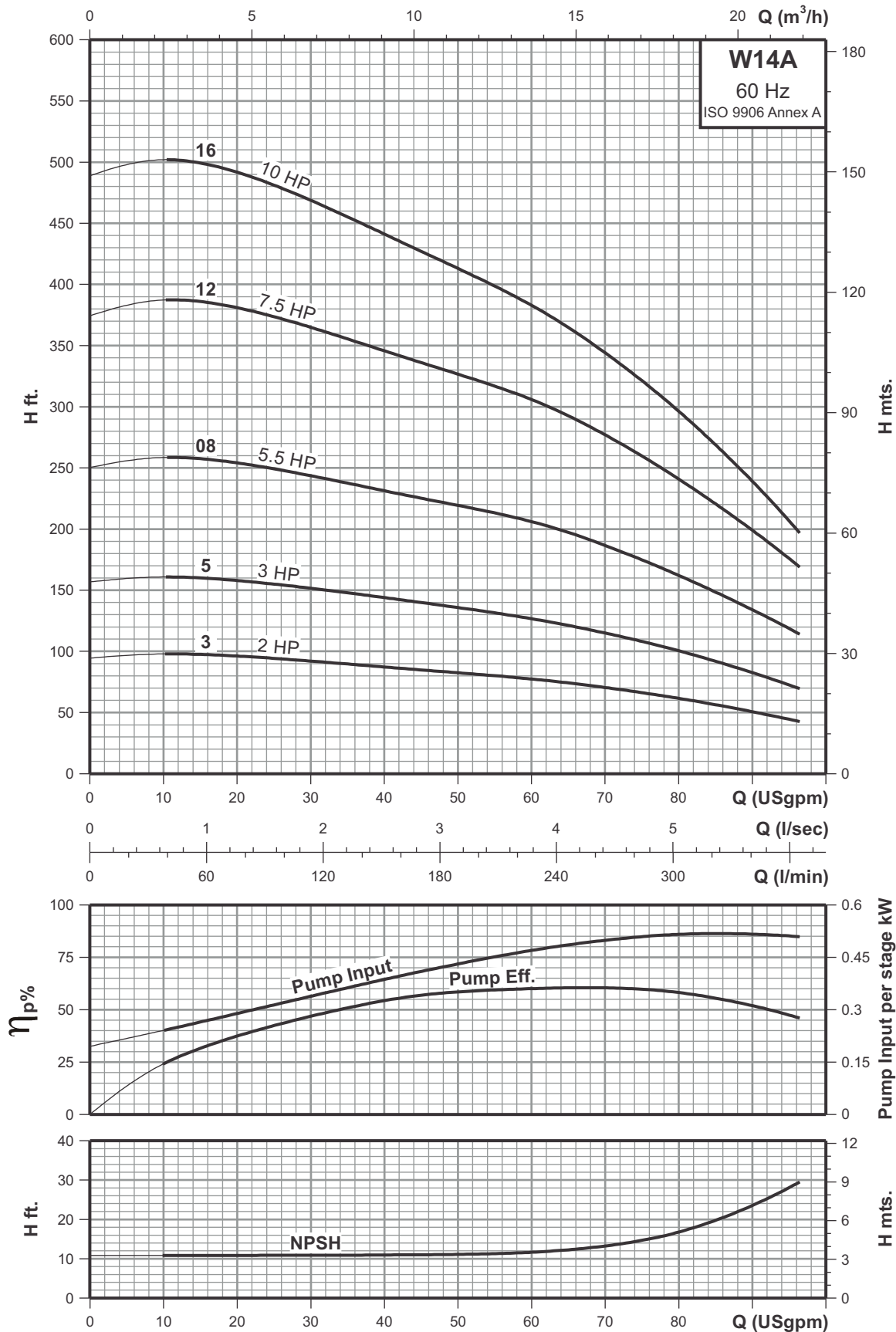

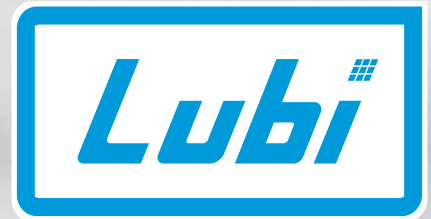

Submersible

Pumps • Motors

60Hz **6"**
Submersible Pump

Pumping Solution

Product data

6"

Stainless steel submersible bore well pumps

Construction

- Submersible motor & pumps for deep wells of 6" (DN 150 mm).
- Sized for connection to the motor according to NEMA standards.
- Delivery casing with built-in non-return valve.
- All standard pumps are completely manufactured out of stainless steel AISI 304 sheet metal.

Impellers:

Radial flow impellers

J6, J9, J12, J17, J17A, J20, J24, J13H, J16H, J18H

Mixed flow impellers

W17, W30, W46, W60

- Connection: Screwed pipe connection with NPT thread as standard.

Applications

- Water supply
- Irrigation
- Civil
- Industrial
- Fire fighting

Performance range

- Flow range: Max. 409.5 USgpm
- Head range: Max. 2201 feet

Operating conditions

- Liquid temperature: +32°F to +113°F
- Max. sand content into the water: 50 g/m³
- Max. starts per hour: 20 at regular intervals
- Direction of rotation: Clockwise as seen from the pump coupling side

Special construction on request

- Also available in stainless steel AISI 316 material.
- Also available with BSP thread pipe connection.



Construction

Stainless steel submersible bore well pumps

6"

Sectional drawing

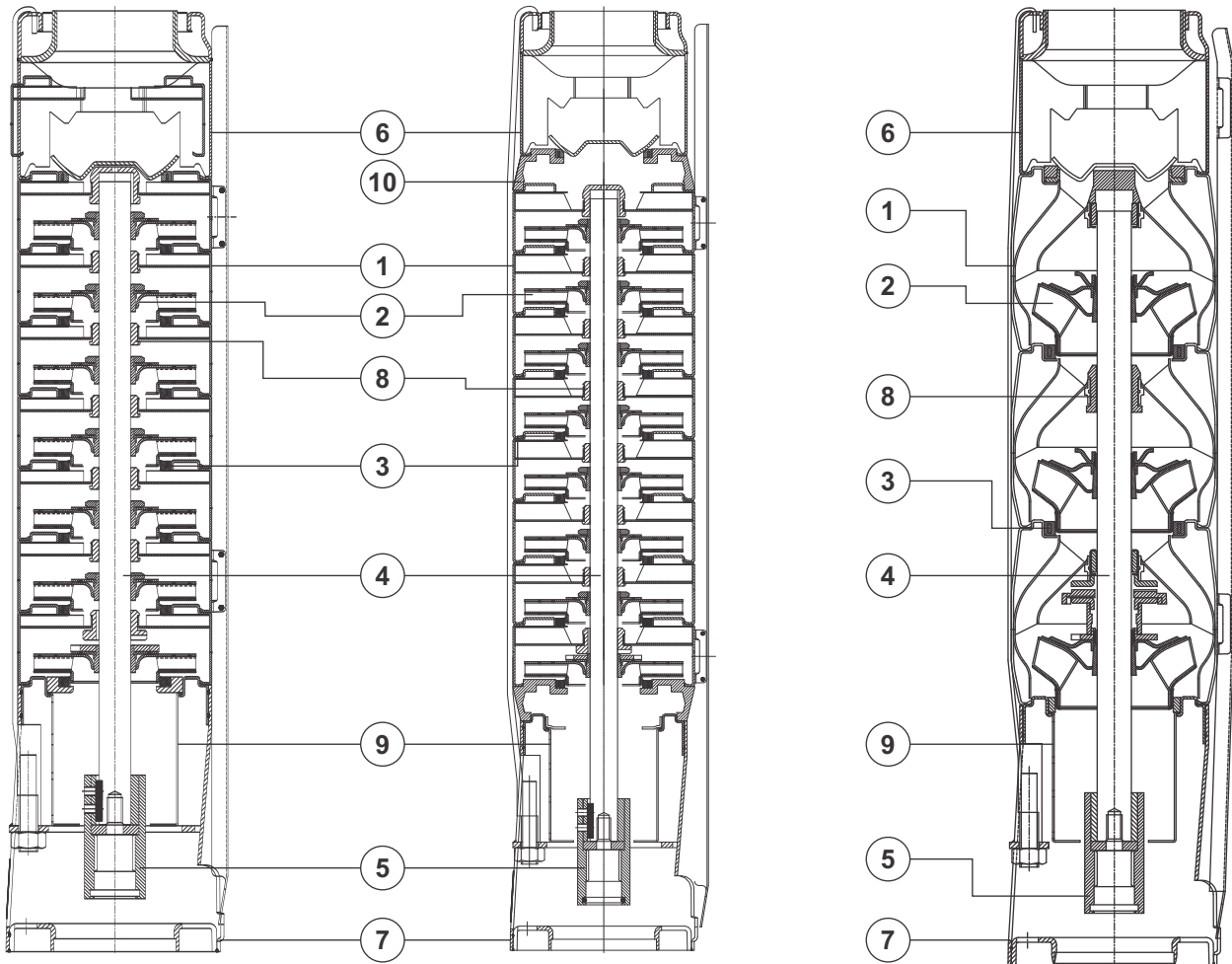

"J" type pump
J6, J9, J12, J17, J17A, J20, J24

"J" type pump
J13H, J16H, J18H

"W" type pump
W17, W30, W46, W60

Materials

Pos.	Component	Material	
		"J" type pump	"W" type pump
1	Bowl / Diffuser	Stainless steel AISI 304	Stainless steel AISI 304
2	Impeller	Stainless steel AISI 304	Stainless steel AISI 304
3	Neck ring	NBR	NBR
4	Shaft	Stainless steel AISI 431	Stainless steel AISI 431
5	Couple	Stainless steel AISI 316	Stainless steel AISI 316
6	Delivery casing	Stainless steel AISI 304	Stainless steel AISI 304
7	Suction case	Stainless steel AISI 304	Stainless steel AISI 304
8	Bearing bush	NBR	NBR
9	Strainer	Stainless steel AISI 304	Stainless steel AISI 304
10	Connector	Stainless steel AISI 304	-

Technical data

Radial flow 6" stainless steel submersible bore well pumps

J6

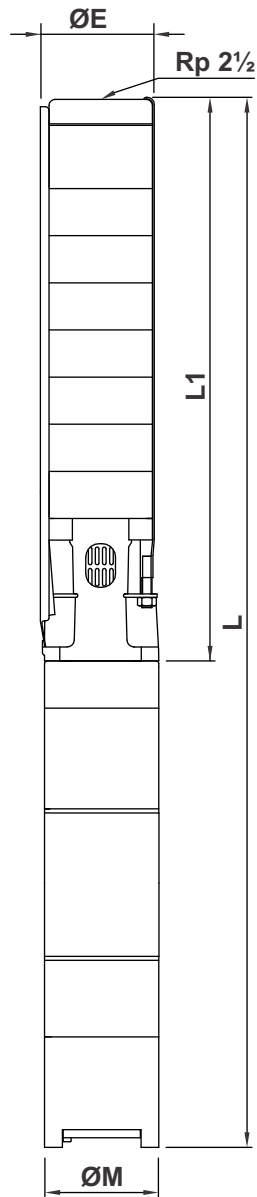

Performance chart

Pump type	Motor type		HP	kW	Q l/min USgpm	n = 3450 rpm						
	Oil filled	Water filled				0	64	95	132	174	204	240
						0	17	25	34.9	46	53.9	63.4
J6/10	H4675	L4675	7.50	5.50	H ft.	476	427	397	354	295	236	141
J6/11	H4675	L4675	7.50	5.50		523	469	437	390	325	260	155
J6/12	H46100	L6610-KP	10.0	7.50		571	512	476	425	354	283	169
J6/13	H46100	L6610-KP	10.0	7.50		618	554	516	461	384	307	183
J6/14	H46100	L6610-KP	10.0	7.50		666	597	556	496	413	331	198
J6/15	-	L6612-KP	12.5	9.30		714	640	595	531	443	354	212
J6/16	-	L6612-KP	12.5	9.30		761	682	635	567	472	378	226
J6/17	-	L6612-KP	12.5	9.30		809	725	675	602	502	402	240
J6/18	-	L6612-KP	12.5	9.30		856	768	715	638	531	425	254
J6/19	-	L6615-KP	15.0	11.0		904	810	754	673	561	449	268
J6/20	-	L6615-KP	15.0	11.0		951	853	794	709	591	472	282
J6/21	-	L6615-KP	15.0	11.0		999	896	834	744	620	496	296
J6/22	-	L6615-KP	15.0	11.0		1047	938	873	780	650	520	310
J6/23	-	L6617-KP	17.5	13.0		1094	981	913	815	679	543	324

Dimensions & weights of pump with Oil filled motor

Type Pump + Motor	ØM [inch]	ØE [inch]	Length [inch]			Gross weight [lbs]			Gross volume [ft³]		
			L1	L		Pump	Pump+Motor		Pump	Pump+Motor	
				1 ~	3 ~		1 ~	3 ~		1 ~	3 ~
J6/10 + H4675	3.74	5.59	27.83	-	54.02	36	-	91	0.8	-	1.3
J6/11 + H4675	3.74	5.59	29.61	-	55.79	40	-	95	0.8	-	1.3
J6/12 + H46100	3.74	5.59	31.38	-	63.07	44	-	113	0.8	-	1.3
J6/13 + H46100	3.74	5.59	33.15	-	64.84	46	-	116	0.8	-	1.3
J6/14 + H46100	3.74	5.59	34.92	-	66.61	48	-	118	0.8	-	1.3

Dimensions & weights of pump with Water filled motor

Type Pump + Motor	ØM [inch]	ØE [inch]	Length [inch]			Gross weight [lbs]			Gross volume [ft³]		
			L1	L		Pump	Pump+Motor		Pump	Pump+Motor	
				1 ~	3 ~		1 ~	3 ~		1 ~	3 ~
J6/10 + L4675	3.74	5.59	27.83	-	62.91	36	-	112	0.8	-	1.3
J6/11 + L4675	3.74	5.59	29.61	-	64.69	40	-	116	0.8	-	1.3
J6/12 + L6610-KP	5.59	5.59	32.01	-	59.88	44	-	163	0.8	-	1.7
J6/13 + L6610-KP	5.59	5.59	33.78	-	61.65	46	-	165	0.8	-	1.7
J6/14 + L6610-KP	5.59	5.59	35.55	-	63.43	48	-	167	0.8	-	1.7
J6/15 + L6612-KP	5.59	5.59	37.32	-	67.17	50	-	181	0.8	-	1.7
J6/16 + L6612-KP	5.59	5.59	39.09	-	68.94	56	-	187	1.3	-	2.2
J6/17 + L6612-KP	5.59	5.59	40.87	-	70.71	58	-	189	1.3	-	2.2
J6/18 + L6612-KP	5.59	5.59	42.64	-	72.48	60	-	191	1.3	-	2.2
J6/19 + L6615-KP	5.59	5.59	44.41	-	75.83	63	-	204	1.3	-	2.4
J6/20 + L6615-KP	5.59	5.59	46.18	-	77.60	67	-	207	1.3	-	2.4
J6/21 + L6615-KP	5.59	5.59	48.46	-	79.88	69	-	209	1.3	-	2.4
J6/22 + L6615-KP	5.59	5.59	50.24	-	81.65	71	-	212	1.3	-	2.4
J6/23 + L6617-KP	5.59	5.59	52.01	-	84.80	75	-	224	1.3	-	2.4

Note: ØE = For single cable motor maximum diameter of pump inclusive of cable guard.
For two cable motor maximum diameter of pump inclusive of cable guard will increase by 0.12 inch.

Rp 2 & Rp 3 are available on request.

All dimensions in inches unless otherwise noted.

Performance curves

Radial flow 6" stainless steel submersible bore well pumps

J6

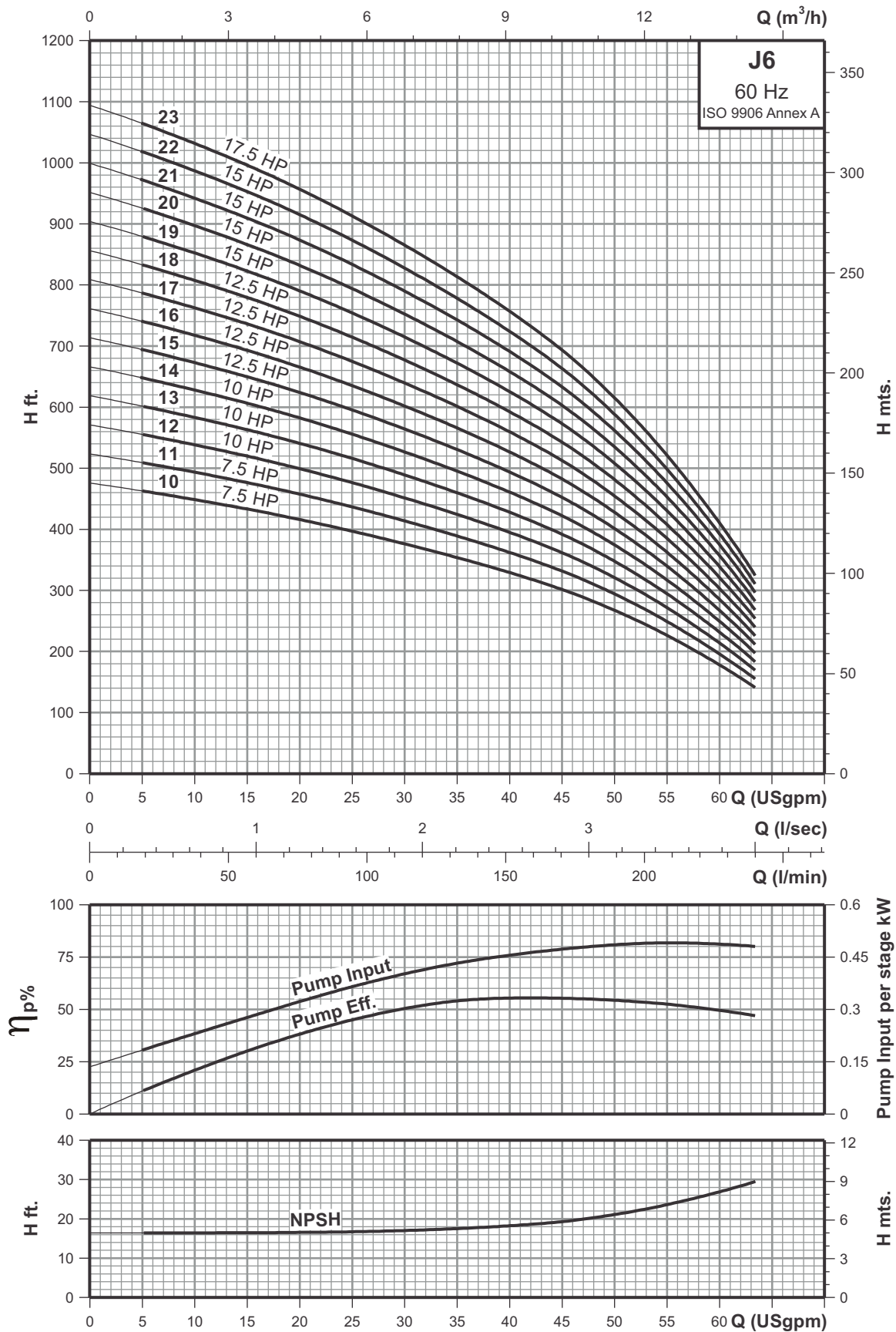

Technical data

Radial flow 6" stainless steel submersible bore well pumps

J6

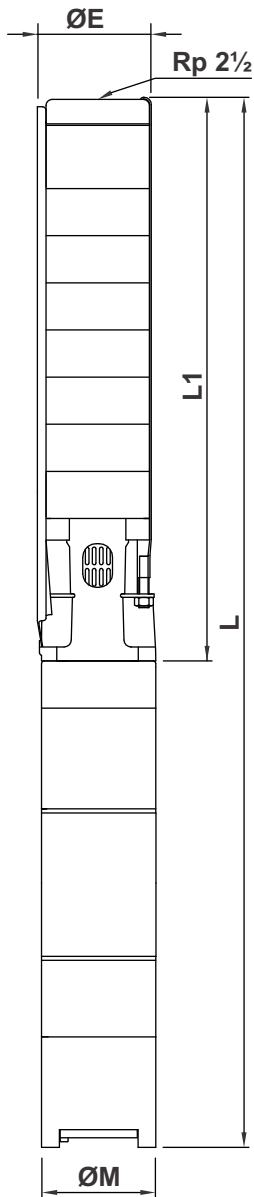

Performance chart

Pump type	Motor type	HP	kW	Q	n = 3450 rpm						
					l/min	0	64	95	132	174	204
	Water filled	USgpm	0	17	25	34.9	46	53.9	63.4		
J6/24	L6617-KP	17.5	13.0	H ft.	1142	1024	953	850	709	567	339
J6/25	L6617-KP	17.5	13.0		1189	1066	992	886	738	591	353
J6/26	L6620-KP	20.0	15.0		1237	1109	1032	921	768	614	367
J6/27	L6620-KP	20.0	15.0		1284	1152	1072	957	797	638	381
J6/28	L6620-KP	20.0	15.0		1332	1194	1112	992	827	661	395
J6/29	L6620-KP	20.0	15.0		1380	1237	1151	1028	856	685	409
J6/30	L6625-KP	25.0	18.5		1427	1280	1191	1063	886	709	423
J6/31	L6625-KP	25.0	18.5		1475	1322	1231	1098	915	732	437
J6/32	L6625-KP	25.0	18.5		1522	1365	1270	1134	945	756	451
J6/33	L6625-KP	25.0	18.5		1570	1407	1310	1169	974	780	466
J6/34	L6625-KP	25.0	18.5		1617	1450	1350	1205	1004	803	480
J6/35	L6625-KP	25.0	18.5		1665	1493	1389	1240	1033	827	494
J6/36	L6625-KP	25.0	18.5		1713	1535	1429	1276	1063	850	508

Dimensions & weights of pump with Water filled motor

Type Pump + Motor	$\varnothing M$ [inch]	$\varnothing E$ [inch]	Length [inch]		Gross weight [lbs]			Gross volume [ft ³]			
			L1	L		Pump	Pump+Motor		Pump	Pump+Motor	
				1 ~	3 ~		1 ~	3 ~		1 ~	3 ~
J6/24 + L6617-KP	5.59	5.59	53.78	-	86.57	78	-	228	1.3	-	2.4
J6/25 + L6617-KP	5.59	5.59	55.55	-	88.35	80	-	230	1.3	-	2.4
J6/26 + L6620-KP	5.59	5.59	57.32	-	91.30	82	-	237	1.3	-	2.4
J6/27 + L6620-KP	5.59	5.59	59.09	-	93.07	84	-	239	1.3	-	2.4
J6/28 + L6620-KP	5.59	5.59	60.87	-	94.84	87	-	242	1.6	-	2.7
J6/29 + L6620-KP	5.59	5.59	62.64	-	96.61	90	-	244	1.6	-	2.7
J6/30 + L6625-KP	5.59	5.59	64.41	-	101.14	92	-	264	1.6	-	2.7
J6/31 + L6625-KP	5.59	5.59	66.18	-	102.91	94	-	266	1.6	-	2.7
J6/32 + L6625-KP	5.59	5.59	67.95	-	104.69	96	-	269	1.6	-	2.7
J6/33 + L6625-KP	5.59	5.59	69.72	-	106.46	98	-	271	1.6	-	2.7
J6/34 + L6625-KP	5.59	5.59	71.50	-	108.23	101	-	273	1.6	-	2.7
J6/35 + L6625-KP	5.59	5.59	73.27	-	110.00	103	-	275	1.6	-	2.7
J6/36 + L6625-KP	5.59	5.59	75.04	-	111.77	105	-	277	1.6	-	2.7

Note: $\varnothing E$ = For single cable motor maximum diameter of pump inclusive of cable guard.
 For two cable motor maximum diameter of pump inclusive of cable guard will increase by 0.12 inch.
 Rp 2 & Rp 3 are available on request.
 All dimensions in inches unless otherwise noted.

Performance curves

Radial flow 6" stainless steel submersible bore well pumps

J6

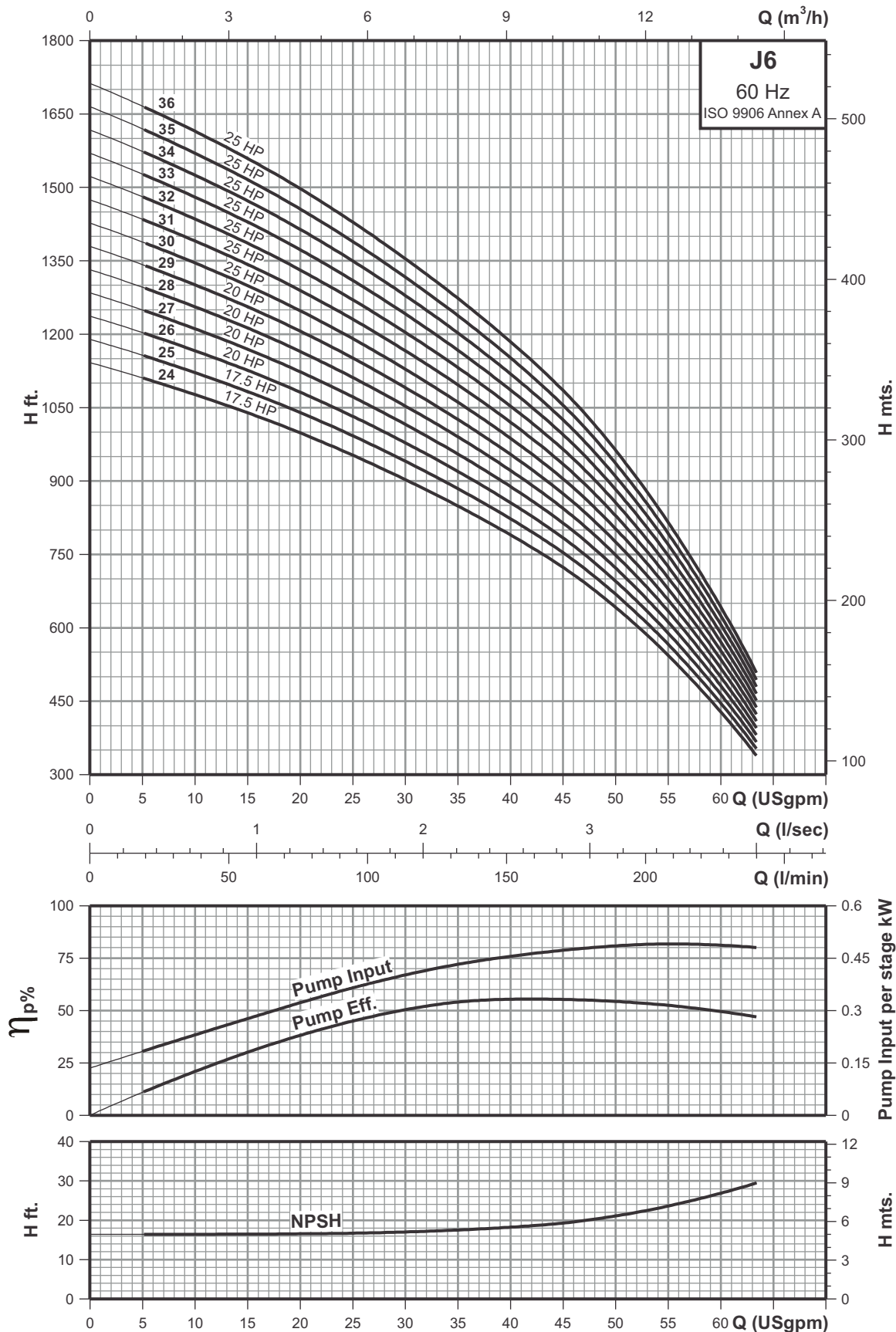

Technical data

Radial flow 6" stainless steel submersible bore well pumps

J9

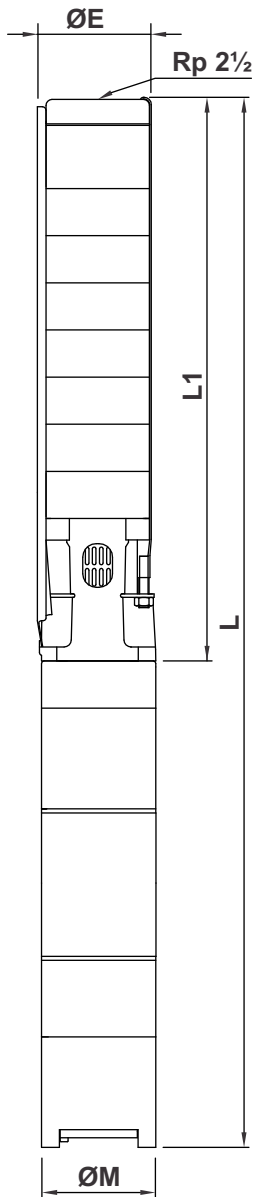

Performance chart

Pump type	Motor type		HP	kW	Q l/min USgpm	n = 3450 rpm						
	Oil filled	Water filled				0	114	148	180	222	264	318
						0	30	39	47.6	58.6	69.7	84
J9/8	H4675	L4675	7.50	5.50	H ft.	381	335	312	282	230	151	26
J9/9	H4675	L4675	7.50	5.50		428	376	351	317	258	170	30
J9/10	H46100	L6610-KP	10.0	7.50		476	418	390	353	287	189	33
J9/11	H46100	L6610-KP	10.0	7.50		523	460	429	388	316	208	36
J9/12	H46100	L6610-KP	10.0	7.50		571	502	468	423	344	226	39
J9/13	-	L6612-KP	12.5	9.30		618	544	506	458	373	245	43
J9/14	-	L6612-KP	12.5	9.30		666	586	545	494	402	264	46
J9/15	-	L6615-KP	15.0	11.0		714	627	584	529	431	283	49
J9/16	-	L6615-KP	15.0	11.0		761	669	623	564	459	302	52
J9/17	-	L6615-KP	15.0	11.0		809	711	662	600	488	321	56
J9/18	-	L6617-KP	17.5	13.0		856	753	701	635	517	340	59
J9/19	-	L6617-KP	17.5	13.0		904	795	740	670	545	358	62
J9/20	-	L6617-KP	17.5	13.0		951	837	779	705	574	377	66
J9/21	-	L6620-KP	20.0	15.0		999	878	818	741	603	396	69
J9/22	-	L6620-KP	20.0	15.0		1047	920	857	776	632	415	72
J9/23	-	L6620-KP	20.0	15.0		1094	962	896	811	660	434	75
J9/24	-	L6620-KP	20.0	15.0		1142	1004	935	846	689	453	79

Dimensions & weights of pump with Oil filled motor

Type Pump + Motor	$\varnothing M$ [inch]	$\varnothing E$ [inch]	Length [inch]			Gross weight [lbs]			Gross volume [ft ³]		
			L1	L		Pump	Pump+Motor		Pump	Pump+Motor	
				1 ~	3 ~		1 ~	3 ~		1 ~	3 ~
J9/8 + H4675	3.74	5.59	24.29	-	50.47	30	-	84	0.8	-	1.3
J9/9 + H4675	3.74	5.59	26.06	-	52.24	33	-	87	0.8	-	1.3
J9/10 + H46100	3.74	5.59	27.83	-	59.53	36	-	106	0.8	-	1.3
J9/11 + H46100	3.74	5.59	29.61	-	61.30	40	-	110	0.8	-	1.3
J9/12 + H46100	3.74	5.59	31.38	-	63.07	44	-	113	0.8	-	1.3

Dimensions & weights of pump with Water filled motor

Type Pump + Motor	$\varnothing M$ [inch]	$\varnothing E$ [inch]	Length [inch]			Gross weight [lbs]			Gross volume [ft ³]		
			L1	L		Pump	Pump+Motor		Pump	Pump+Motor	
				1 ~	3 ~		1 ~	3 ~		1 ~	3 ~
J9/8 + L4675	3.74	5.59	24.29	-	59.37	30	-	105	0.8	-	1.3
J9/9 + L4675	3.74	5.59	26.06	-	61.14	33	-	108	0.8	-	1.3
J9/10 + L6610-KP	5.59	5.59	28.46	-	56.34	36	-	155	0.8	-	1.7
J9/11 + L6610-KP	5.59	5.59	30.24	-	58.11	40	-	160	0.8	-	1.7
J9/12 + L6610-KP	5.59	5.59	32.01	-	59.88	44	-	163	0.8	-	1.7
J9/13 + L6612-KP	5.59	5.59	33.78	-	63.62	46	-	177	0.8	-	1.7
J9/14 + L6612-KP	5.59	5.59	35.55	-	65.39	48	-	179	0.8	-	1.7
J9/15 + L6615-KP	5.59	5.59	37.32	-	68.74	50	-	191	0.8	-	1.9
J9/16 + L6615-KP	5.59	5.59	39.09	-	70.51	56	-	196	1.3	-	2.4
J9/17 + L6615-KP	5.59	5.59	40.87	-	72.28	58	-	198	1.3	-	2.4
J9/18 + L6617-KP	5.59	5.59	42.64	-	75.43	60	-	210	1.3	-	2.4
J9/19 + L6617-KP	5.59	5.59	44.41	-	77.20	63	-	213	1.3	-	2.4
J9/20 + L6617-KP	5.59	5.59	46.18	-	78.98	67	-	216	1.3	-	2.4
J9/21 + L6620-KP	5.59	5.59	48.46	-	82.44	69	-	224	1.3	-	2.4
J9/22 + L6620-KP	5.59	5.59	50.24	-	84.21	71	-	226	1.3	-	2.4
J9/23 + L6620-KP	5.59	5.59	52.01	-	85.98	75	-	230	1.3	-	2.4
J9/24 + L6620-KP	5.59	5.59	53.78	-	87.76	78	-	233	1.3	-	2.4

Note: $\varnothing E$ = For single cable motor maximum diameter of pump inclusive of cable guard.
For two cable motor maximum diameter of pump inclusive of cable guard will increase by 0.12 inch.

Rp 2 & Rp 3 are available on request.

All dimensions in inches unless otherwise noted.

Performance curves

Radial flow 6" stainless steel submersible bore well pumps

J9

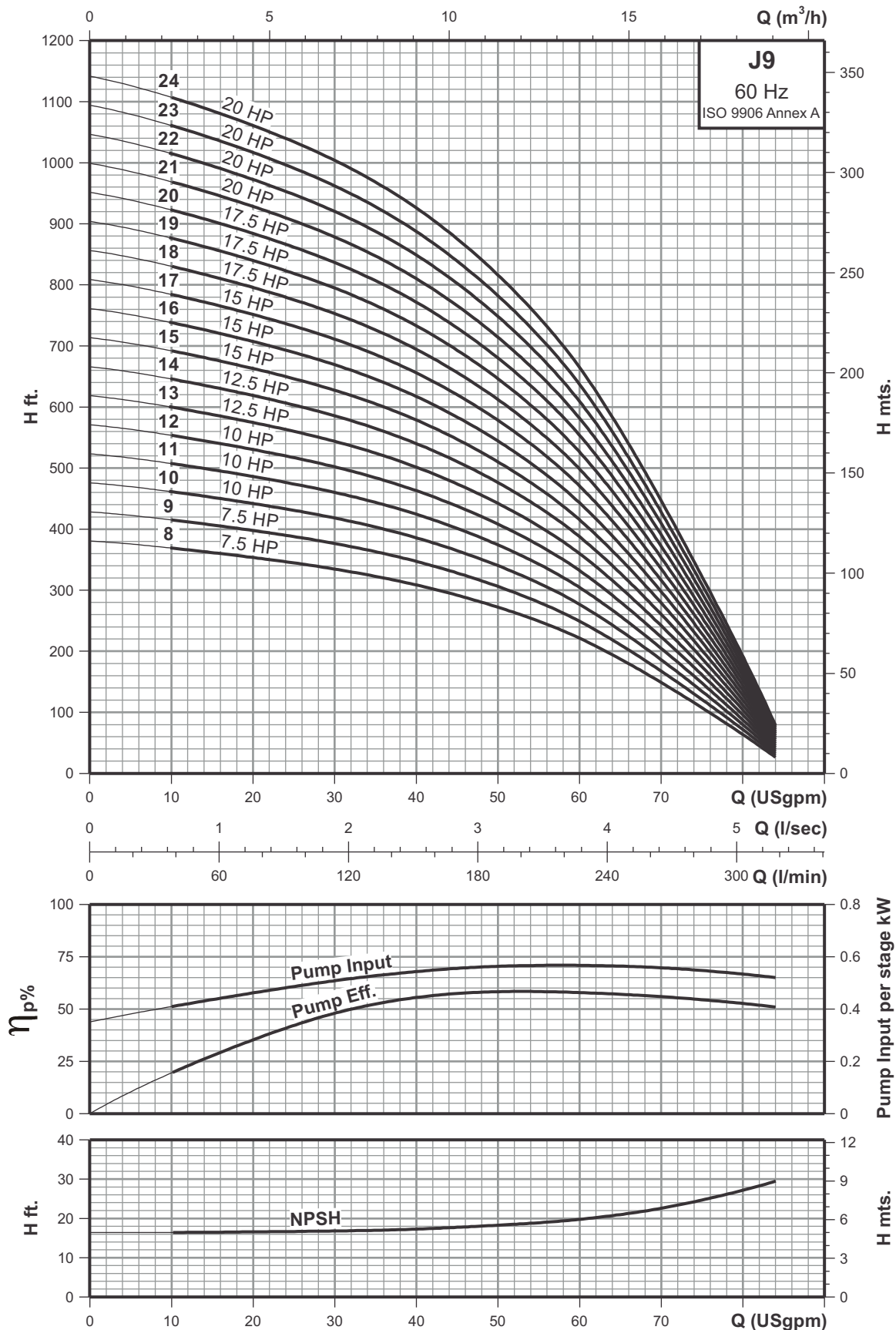

Technical data

Radial flow 6" stainless steel submersible bore well pumps

J9

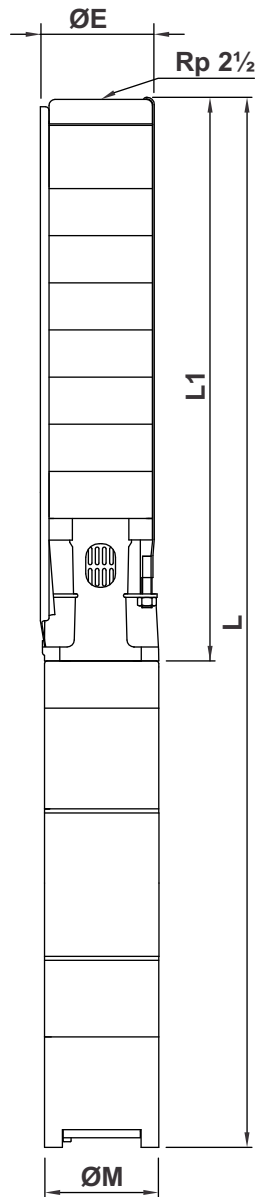

Performance chart

Pump type	Motor type	HP	kW	Q	n = 3450 rpm						
					l/min	0	114	148	180	222	264
	Water filled	USgpm	0	30	39	47.6	58.6	69.7	84		
J9/25	L6625-KP	25.0	18.5	H ft.	1189	1046	974	882	718	472	82
J9/26	L6625-KP	25.0	18.5		1237	1088	1013	917	746	490	85
J9/27	L6625-KP	25.0	18.5		1284	1129	1052	952	775	509	89
J9/28	L6625-KP	25.0	18.5		1332	1171	1091	988	804	528	92
J9/29	L6625-KP	25.0	18.5		1380	1213	1130	1023	833	547	95
J9/30	L6630-KP	30.0	22.0		1427	1255	1169	1058	861	566	98
J9/31	L6630-KP	30.0	22.0		1475	1297	1208	1093	890	585	102
J9/32	L6630-KP	30.0	22.0		1522	1339	1247	1129	919	604	105
J9/33	L6630-KP	30.0	22.0		1570	1380	1286	1164	947	623	108
J9/34	L6630-KP	30.0	22.0		1617	1422	1325	1199	976	641	112
J9/35	L6635-KP	35.0	26.0		1665	1464	1364	1234	1005	660	115
J9/36	L6635-KP	35.0	26.0		1713	1506	1403	1270	1033	679	118

Dimensions & weights of pump with Water filled motor

Type Pump + Motor	ØM [inch]	ØE [inch]	Length [inch]			Gross weight [lbs]			Gross volume [ft³]		
			L1	L		Pump	Pump+Motor		Pump	Pump+Motor	
				1 ~	3 ~		1 ~	3 ~		1 ~	3 ~
J9/25 + L6625-KP	5.59	5.59	55.55	-	92.28	80	-	252	1.3	-	2.4
J9/26 + L6625-KP	5.59	5.59	57.32	-	94.06	82	-	255	1.3	-	2.4
J9/27 + L6625-KP	5.59	5.59	59.09	-	95.83	84	-	257	1.3	-	2.4
J9/28 + L6625-KP	5.59	5.59	60.87	-	97.60	87	-	260	1.6	-	2.7
J9/29 + L6625-KP	5.59	5.59	62.64	-	99.37	90	-	262	1.6	-	2.7
J9/30 + L6630-KP	5.59	5.59	64.41	-	103.50	92	-	278	1.6	-	2.7
J9/31 + L6630-KP	5.59	5.59	66.18	-	105.28	94	-	280	1.6	-	2.7
J9/32 + L6630-KP	5.59	5.59	67.95	-	107.05	96	-	282	1.6	-	2.7
J9/33 + L6630-KP	5.59	5.59	69.72	-	108.82	98	-	284	1.6	-	2.7
J9/34 + L6630-KP	5.59	5.59	71.50	-	110.59	101	-	286	1.6	-	2.7
J9/35 + L6635-KP	5.59	5.59	73.27	-	114.72	103	-	332	1.6	-	6.0
J9/36 + L6635-KP	5.59	5.59	75.04	-	116.50	105	-	334	1.6	-	6.0

Note: ØE = For single cable motor maximum diameter of pump inclusive of cable guard.
For two cable motor maximum diameter of pump inclusive of cable guard will increase by 0.12 inch.

Rp 2 & Rp 3 are available on request.
All dimensions in inches unless otherwise noted.

Performance curves

Radial flow 6" stainless steel submersible bore well pumps

J9

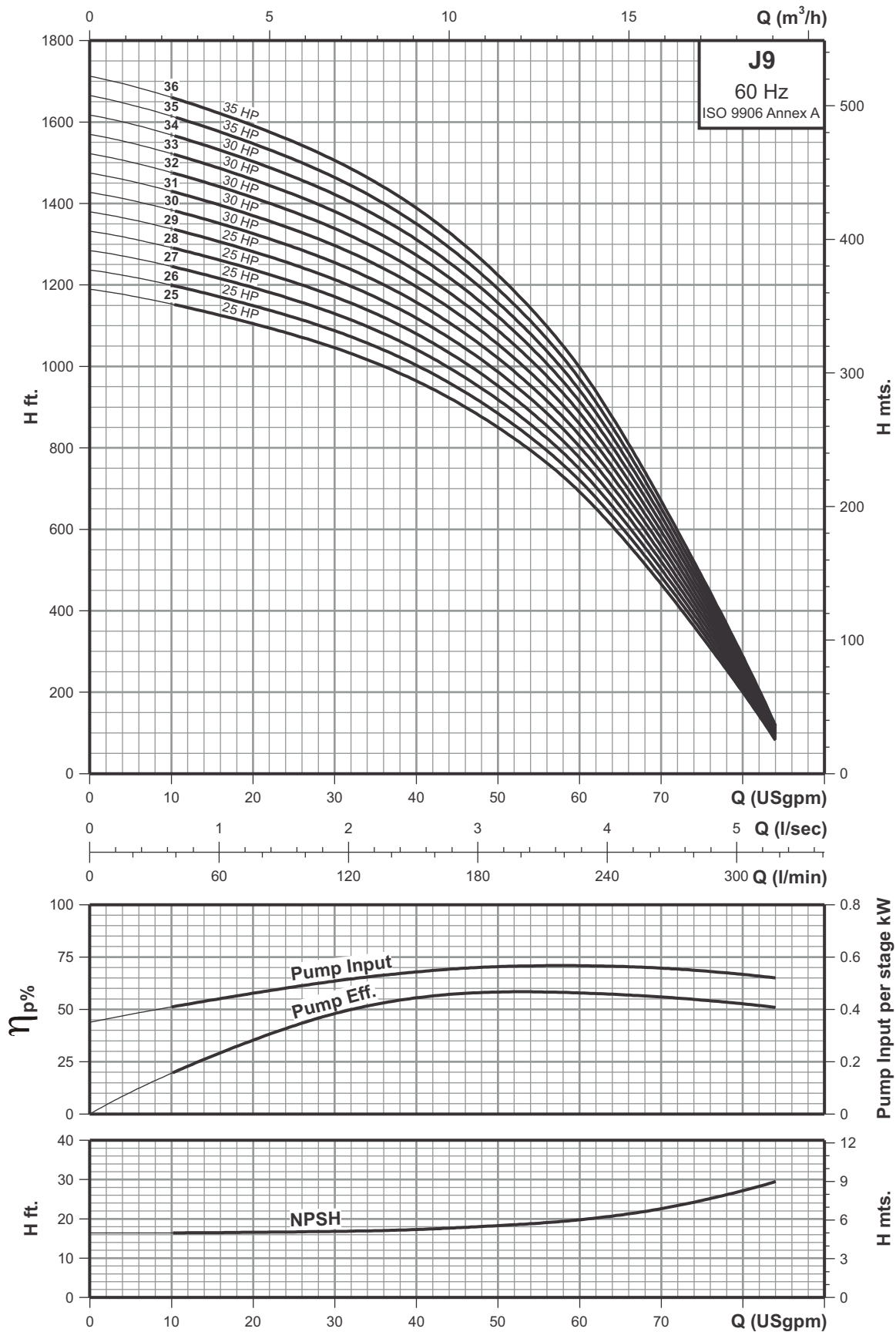

Technical data

Radial flow 6" stainless steel submersible bore well pumps

J12

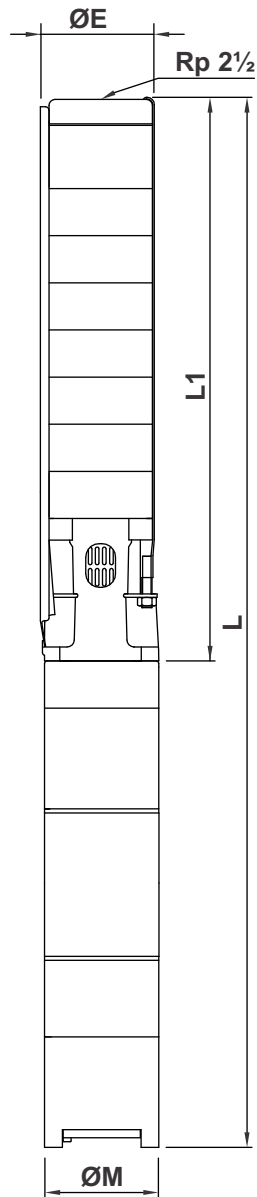

Performance chart

Pump type	Motor type		HP	kW	Q l/min USgpm	n = 3450 rpm						
	Oil filled	Water filled				0	167	201	242	282	330	372
						0	44	53	64	74.5	87.2	98.3
J12/6	H4675	L4675	7.50	5.50	H ft.	295	253	236	210	177	125	69
J12/7	H4675	L4675	7.50	5.50		344	295	276	245	207	145	80
J12/8	H46100	L6610-KP	10.0	7.50		394	337	315	280	236	166	92
J12/9	H46100	L6610-KP	10.0	7.50		443	379	354	315	266	187	103
J12/10	-	L6612-KP	12.5	9.30		492	421	394	350	295	208	115
J12/11	-	L6612-KP	12.5	9.30		541	463	433	385	325	229	126
J12/12	-	L6612-KP	12.5	9.30		591	505	472	420	354	249	138
J12/13	-	L6615-KP	15.0	11.0		640	547	512	455	384	270	149
J12/14	-	L6615-KP	15.0	11.0		689	589	551	490	413	291	161
J12/15	-	L6617-KP	17.5	13.0		738	632	591	525	443	312	172
J12/16	-	L6617-KP	17.5	13.0		787	674	630	560	472	332	184
J12/17	-	L6617-KP	17.5	13.0		837	716	669	595	502	353	195
J12/18	-	L6620-KP	20.0	15.0		886	758	709	630	531	374	207
J12/19	-	L6620-KP	20.0	15.0		935	800	748	665	561	395	218
J12/20	-	L6625-KP	25.0	18.5		984	842	787	700	591	416	230
J12/21	-	L6625-KP	25.0	18.5		1033	884	827	735	620	436	241
J12/22	-	L6625-KP	25.0	18.5		1083	926	866	770	650	457	253
J12/23	-	L6625-KP	25.0	18.5		1132	968	906	805	679	478	264
J12/24	-	L6625-KP	25.0	18.5		1181	1010	945	840	709	499	276
J12/25	-	L6630-KP	30.0	22.0		1230	1053	984	875	738	519	287

Dimensions & weights of pump with Oil filled motor

Type Pump + Motor	ØM [inch]	ØE [inch]	Length [inch]			Gross weight [lbs]			Gross volume [ft³]		
			L1	L		Pump	Pump+Motor		Pump	Pump+Motor	
				1 ~	3 ~		1 ~	3 ~		1 ~	3 ~
J12/6 + H4675	3.74	5.59	20.75	-	46.93	24	-	78	0.8	-	1.3
J12/7 + H4675	3.74	5.59	22.52	-	48.70	26	-	81	0.8	-	1.3
J12/8 + H46100	3.74	5.59	24.29	-	55.98	30	-	99	0.8	-	1.3
J12/9 + H46100	3.74	5.59	26.06	-	57.76	33	-	102	0.8	-	1.3

Dimensions & weights of pump with Water filled motor

Type Pump + Motor	ØM [inch]	ØE [inch]	Length [inch]			Gross weight [lbs]			Gross volume [ft³]		
			L1	L		Pump	Pump+Motor		Pump	Pump+Motor	
				1 ~	3 ~		1 ~	3 ~		1 ~	3 ~
J12/6 + L4675	3.74	5.59	20.75	-	55.83	24	-	99	0.8	-	1.3
J12/7 + L4675	3.74	5.59	22.52	-	57.60	26	-	102	0.8	-	1.3
J12/8 + L6610-KP	5.59	5.59	24.92	-	52.80	30	-	149	0.8	-	1.7
J12/9 + L6610-KP	5.59	5.59	26.69	-	54.57	33	-	152	0.8	-	1.7
J12/10 + L6612-KP	5.59	5.59	28.46	-	58.31	36	-	167	0.8	-	1.7
J12/11 + L6612-KP	5.59	5.59	30.24	-	60.08	40	-	171	0.8	-	1.7
J12/12 + L6612-KP	5.59	5.59	32.01	-	61.85	44	-	175	0.8	-	1.7
J12/13 + L6615-KP	5.59	5.59	33.78	-	65.20	46	-	186	0.8	-	1.9
J12/14 + L6615-KP	5.59	5.59	35.55	-	66.97	48	-	188	0.8	-	1.9
J12/15 + L6617-KP	5.59	5.59	37.32	-	70.12	50	-	200	0.8	-	1.9
J12/16 + L6617-KP	5.59	5.59	39.09	-	71.89	56	-	205	1.3	-	2.4
J12/17 + L6617-KP	5.59	5.59	40.87	-	73.66	58	-	208	1.3	-	2.4
J12/18 + L6620-KP	5.59	5.59	42.64	-	76.61	60	-	215	1.3	-	2.4
J12/19 + L6620-KP	5.59	5.59	44.41	-	78.39	63	-	218	1.3	-	2.4
J12/20 + L6625-KP	5.59	5.59	46.18	-	82.91	67	-	239	1.3	-	2.4
J12/21 + L6625-KP	5.59	5.59	48.46	-	85.20	69	-	241	1.3	-	2.4
J12/22 + L6625-KP	5.59	5.59	50.24	-	86.97	71	-	244	1.3	-	2.4
J12/23 + L6625-KP	5.59	5.59	52.01	-	88.74	75	-	247	1.3	-	2.4
J12/24 + L6625-KP	5.59	5.59	53.78	-	90.51	78	-	250	1.3	-	2.4
J12/25 + L6630-KP	5.59	5.59	55.55	-	94.65	80	-	266	1.3	-	2.4

Note: ØE = For single cable motor maximum diameter of pump inclusive of cable guard.
For two cable motor maximum diameter of pump inclusive of cable guard will increase by 0.12 inch.

Rp 2 & Rp 3 are available on request.
All dimensions in inches unless otherwise noted.

Performance curves

Radial flow 6" stainless steel submersible bore well pumps

J12

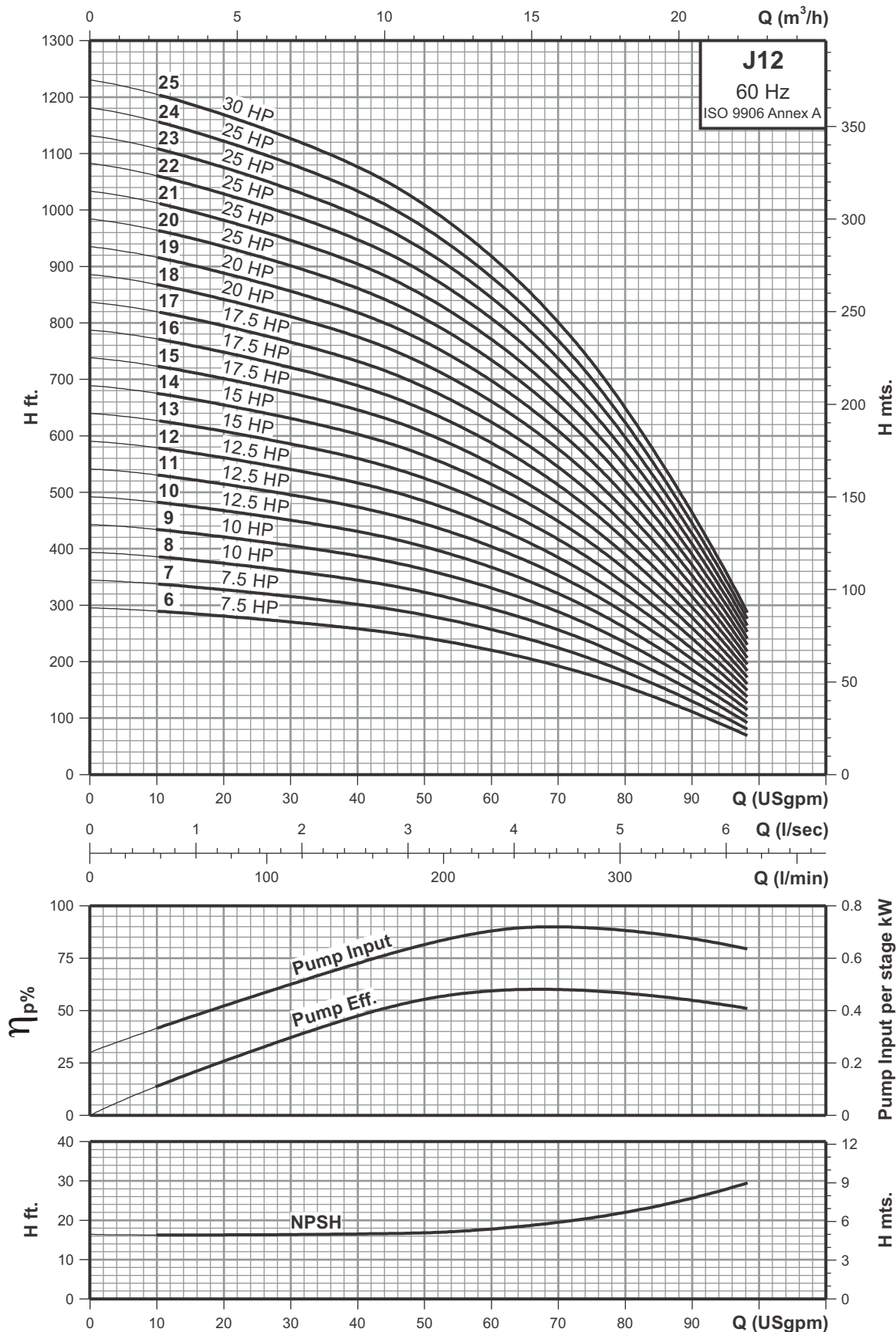

Technical data

Radial flow 6" stainless steel submersible bore well pumps

J12

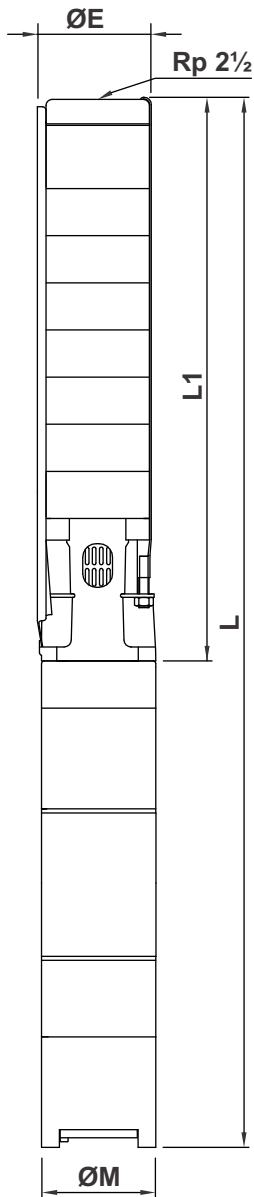

Performance chart

Pump type	Motor type	HP	kW	Q l/min	n = 3450 rpm						
					Water filled						
	USgpm	0	167	201	242	282	330	372			
J12/26	L6630-KP	30.0	22.0	H ft.	1280	1095	1024	910	768	540	299
J12/27	L6630-KP	30.0	22.0		1329	1137	1063	945	797	561	310
J12/28	L6630-KP	30.0	22.0		1378	1179	1102	980	827	582	322
J12/29	L6630-KP	30.0	22.0		1427	1221	1142	1015	856	603	333
J12/30	L6635-KP	35.0	26.0		1476	1263	1181	1050	886	623	344
J12/31	L6635-KP	35.0	26.0		1526	1305	1220	1085	915	644	356
J12/32	L6635-KP	35.0	26.0		1575	1347	1260	1120	945	665	367
J12/33	L6635-KP	35.0	26.0		1624	1389	1299	1155	974	686	379
J12/34	L6640-KP	40.0	30.0		1673	1432	1339	1190	1004	706	390
J12/35	L6640-KP	40.0	30.0		1722	1474	1378	1225	1033	727	402
J12/36	L6640-KP	40.0	30.0		1772	1516	1417	1260	1063	748	413

Dimensions & weights of pump with Water filled motor

Type Pump + Motor	ØM [inch]	ØE [inch]	Length [inch]			Gross weight [lbs]			Gross volume [ft³]		
			L1	L		Pump	Pump+Motor		Pump	Pump+Motor	
				1 ~	3 ~		1 ~	3 ~		1 ~	3 ~
J12/26 + L6630-KP	5.59	5.59	57.32	-	96.42	82	-	268	1.3	-	2.4
J12/27 + L6630-KP	5.59	5.59	59.09	-	98.19	84	-	270	1.3	-	2.4
J12/28 + L6630-KP	5.59	5.59	60.87	-	99.96	87	-	273	1.6	-	2.7
J12/29 + L6630-KP	5.59	5.59	62.64	-	101.73	90	-	275	1.6	-	2.7
J12/30 + L6635-KP	5.59	5.59	64.41	-	105.87	92	-	321	1.6	-	6.0
J12/31 + L6635-KP	5.59	5.59	66.18	-	107.64	94	-	323	1.6	-	6.0
J12/32 + L6635-KP	5.59	5.59	67.95	-	109.41	96	-	325	1.6	-	6.0
J12/33 + L6635-KP	5.59	5.59	69.72	-	111.18	98	-	328	1.6	-	6.0
J12/34 + L6640-KP	5.59	5.59	71.50	-	116.10	101	-	347	1.6	-	6.3
J12/35 + L6640-KP	5.59	5.59	73.27	-	117.87	103	-	350	1.6	-	6.3
J12/36 + L6640-KP	5.59	5.59	75.04	-	119.65	105	-	352	1.6	-	6.3

Note: ØE = For single cable motor maximum diameter of pump inclusive of cable guard.
 For two cable motor maximum diameter of pump inclusive of cable guard will increase by 0.12 inch.
 Rp 2 & Rp 3 are available on request.
 All dimensions in inches unless otherwise noted.

Performance curves

Radial flow 6" stainless steel submersible bore well pumps

J12

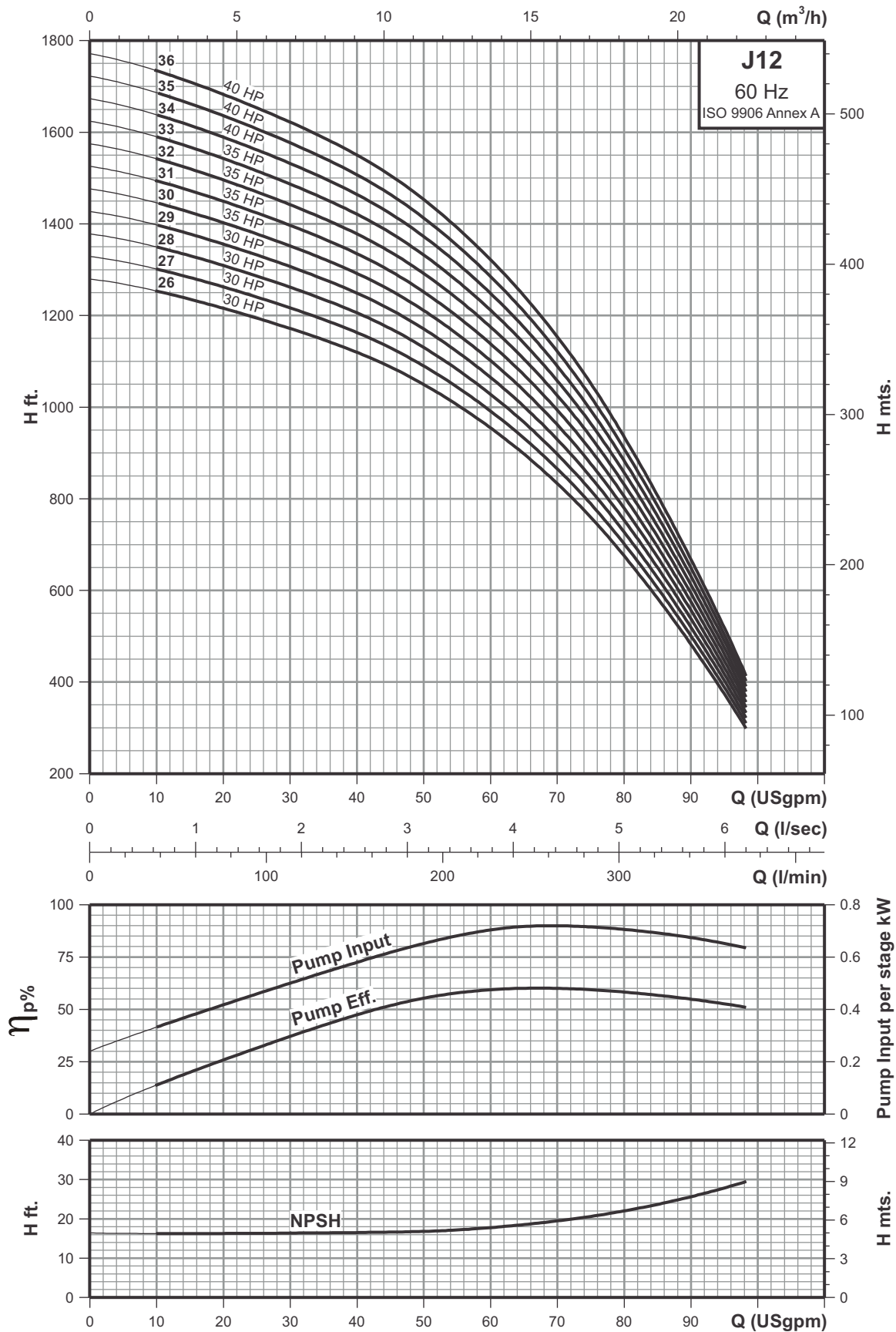

Technical data

Radial flow 6" stainless steel submersible bore well pumps

J17

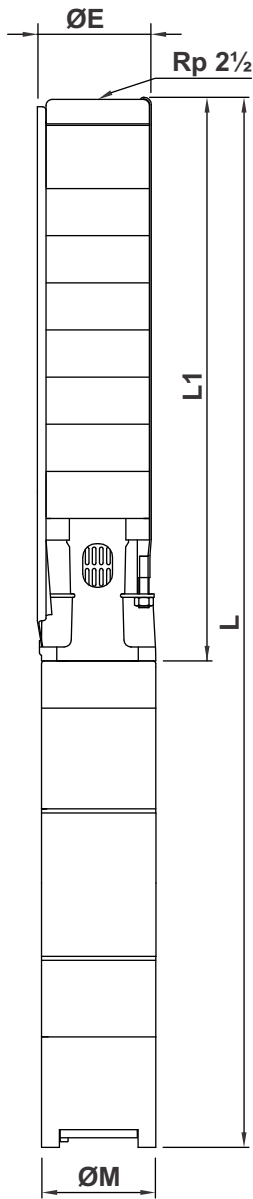

Performance chart

Pump type	Motor type		HP	kW	Q l/min USgpm	n = 3450 rpm						
	Oil filled	Water filled				0	170	223	280	344	409	465
						0	45	59	74	91	108	122.8
J17/5	H4675	L4675	7.50	5.50	H ft.	243	220	207	187	154	108	49
J17/6	H4675	L4675	7.50	5.50		291	264	248	224	185	130	59
J17/7	H46100	L6610-KP	10.0	7.50		340	308	289	262	216	152	69
J17/8	-	L6612-KP	12.5	9.30		388	352	331	299	247	173	79
J17/9	-	L6612-KP	12.5	9.30		437	396	372	337	278	195	89
J17/10	-	L6615-KP	15.0	11.0		486	440	413	374	308	217	98
J17/11	-	L6615-KP	15.0	11.0		534	484	455	411	339	238	108
J17/12	-	L6617-KP	17.5	13.0		583	528	496	449	370	260	118
J17/13	-	L6617-KP	17.5	13.0		631	572	537	486	401	281	128
J17/14	-	L6620-KP	20.0	15.0		680	615	579	524	432	303	138
J17/15	-	L6620-KP	20.0	15.0		728	659	620	561	463	325	148
J17/16	-	L6625-KP	25.0	18.5		777	703	661	598	493	346	157
J17/17	-	L6625-KP	25.0	18.5		825	747	703	636	524	368	167
J17/18	-	L6625-KP	25.0	18.5		874	791	744	673	555	390	177
J17/19	-	L6625-KP	25.0	18.5		923	835	785	711	586	411	187
J17/20	-	L6630-KP	30.0	22.0		971	879	827	748	617	433	197
J17/21	-	L6630-KP	30.0	22.0		1020	923	868	785	648	455	207
J17/22	-	L6630-KP	30.0	22.0		1068	967	909	823	678	476	217
J17/23	-	L6630-KP	30.0	22.0		1117	1011	951	860	709	498	226
J17/24	-	L6635-KP	35.0	26.0		1165	1055	992	898	740	520	236
J17/25	-	L6635-KP	35.0	26.0	1214	1099	1033	935	771	541	246	
J17/26	-	L6635-KP	35.0	26.0	1262	1143	1075	972	802	563	256	

Dimensions & weights of pump with Oil filled motor

Type Pump + Motor	ØM [inch]	ØE [inch]	Length [inch]			Gross weight [lbs]			Gross volume [ft³]		
			L1	L		Pump	Pump+Motor		Pump	Pump+Motor	
				1 ~	3 ~		1 ~	3 ~		1 ~	3 ~
J17/5 + H4675	3.74	5.59	18.98	-	45.16	24	-	79	0.8	-	1.3
J17/6 + H4675	3.74	5.59	20.75	-	46.93	26	-	81	0.8	-	1.3
J17/7 + H46100	3.74	5.59	22.52	-	54.21	29	-	99	0.8	-	1.3

Dimensions & weights of pump with Water filled motor

Type Pump + Motor	ØM [inch]	ØE [inch]	Length [inch]			Gross weight [lbs]			Gross volume [ft³]		
			L1	L		Pump	Pump+Motor		Pump	Pump+Motor	
				1 ~	3 ~		1 ~	3 ~		1 ~	3 ~
J17/5 + L4675	3.74	5.59	18.98	-	54.06	24	-	100	0.8	-	1.3
J17/6 + L4675	3.74	5.59	20.75	-	55.83	26	-	102	0.8	-	1.3
J17/7 + L6610-KP	5.59	5.59	23.15	-	51.02	29	-	148	0.8	-	1.7
J17/8 + L6612-KP	5.59	5.59	24.92	-	54.76	31	-	162	0.8	-	1.7
J17/9 + L6612-KP	5.59	5.59	26.69	-	56.54	34	-	165	0.8	-	1.7
J17/10 + L6615-KP	5.59	5.59	28.46	-	59.88	37	-	178	0.8	-	1.9
J17/11 + L6615-KP	5.59	5.59	30.24	-	61.65	39	-	180	0.8	-	1.9
J17/12 + L6617-KP	5.59	5.59	32.01	-	64.80	41	-	190	0.8	-	1.9
J17/13 + L6617-KP	5.59	5.59	33.78	-	66.57	43	-	192	0.8	-	1.9
J17/14 + L6620-KP	5.59	5.59	35.55	-	69.53	45	-	200	0.8	-	1.9
J17/15 + L6620-KP	5.59	5.59	37.32	-	71.30	51	-	206	0.8	-	1.9
J17/16 + L6625-KP	5.59	5.59	39.09	-	75.83	52	-	225	1.3	-	2.4
J17/17 + L6625-KP	5.59	5.59	40.87	-	77.60	55	-	227	1.3	-	2.4
J17/18 + L6625-KP	5.59	5.59	42.64	-	79.37	57	-	229	1.3	-	2.4
J17/19 + L6625-KP	5.59	5.59	44.41	-	81.14	58	-	231	1.3	-	2.4
J17/20 + L6630-KP	5.59	5.59	46.18	-	85.28	61	-	246	1.3	-	2.4
J17/21 + L6630-KP	5.59	5.59	48.46	-	87.56	63	-	249	1.3	-	2.4
J17/22 + L6630-KP	5.59	5.59	50.24	-	89.33	66	-	252	1.3	-	2.4
J17/23 + L6630-KP	5.59	5.59	52.01	-	91.10	69	-	254	1.3	-	2.4
J17/24 + L6635-KP	5.59	5.59	53.78	-	95.24	71	-	300	1.3	-	5.6
J17/25 + L6635-KP	5.59	5.59	55.55	-	97.01	72	-	301	1.3	-	5.6
J17/26 + L6635-KP	5.59	5.59	57.32	-	98.78	73	-	302	1.3	-	5.6

Note: ØE = For single cable motor maximum diameter of pump inclusive of cable guard.
For two cable motor maximum diameter of pump inclusive of cable guard will increase by 0.12 inch.

Rp 2 & Rp 3 are available on request.

All dimensions in inches unless otherwise noted.

Performance curves

Radial flow 6" stainless steel submersible bore well pumps

J17

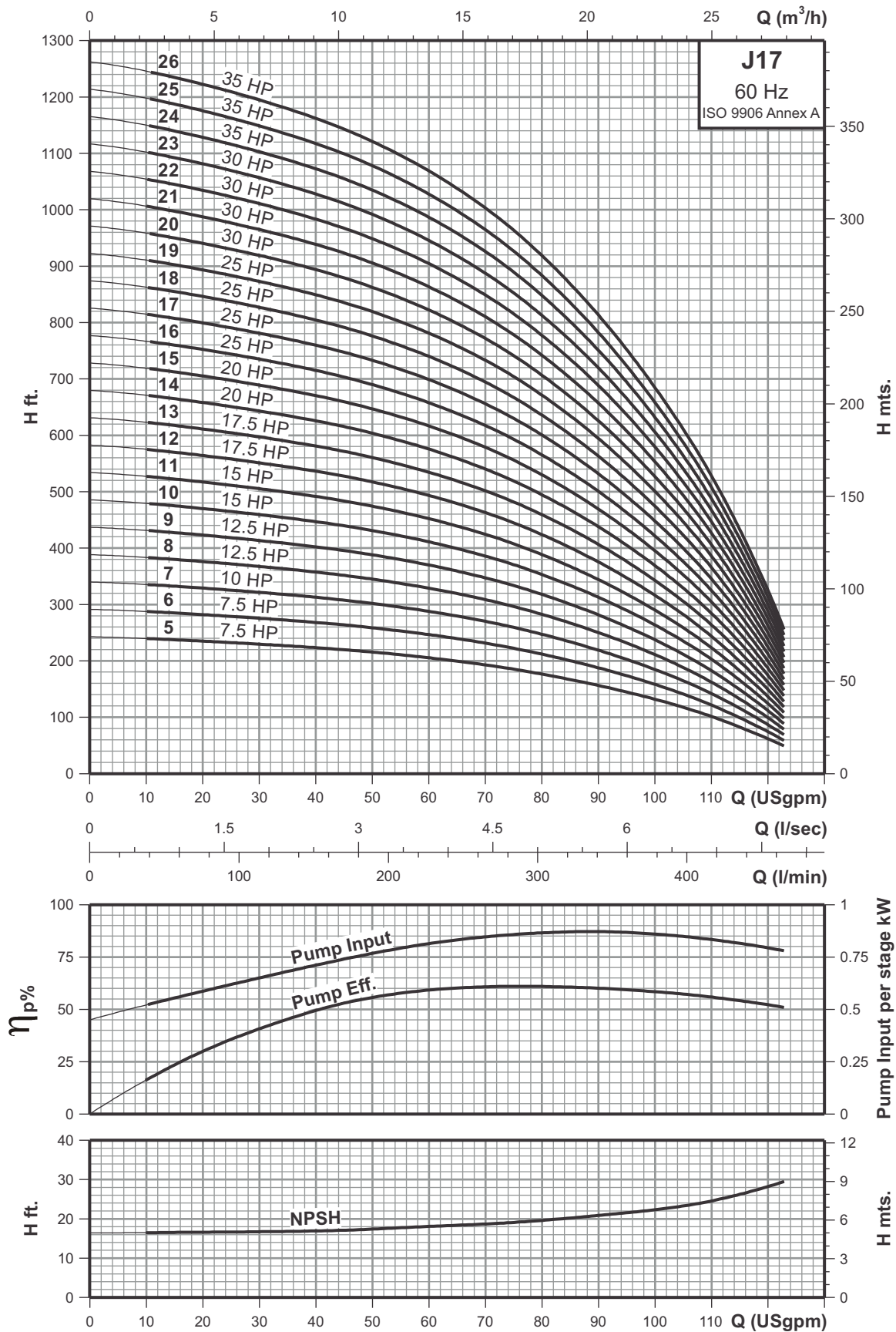

Technical data

Radial flow 6" stainless steel submersible bore well pumps

J17

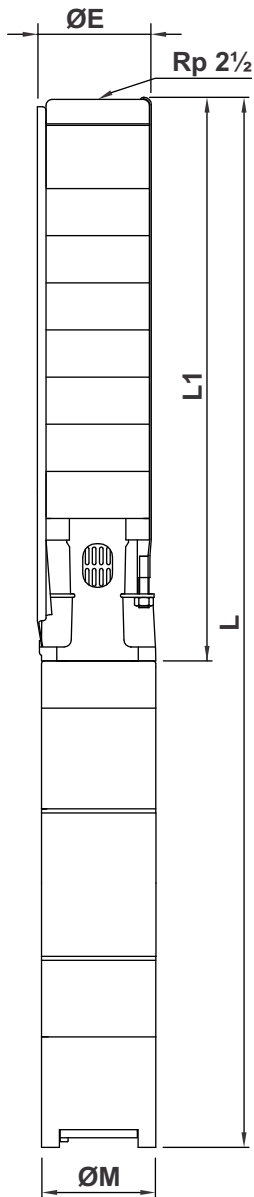

Performance chart

Pump type	Motor type	HP	kW	Q	n = 3450 rpm						
					l/min	0	170	223	280	344	409
	Water filled	USgpm	0	45	59	74	91	108	122.8		
J17/27	L6635-KP	35.0	26.0	H ft.	1311	1187	1116	1010	833	585	266
J17/28	L6640-KP	40.0	30.0		1360	1231	1157	1047	864	606	276
J17/29	L6640-KP	40.0	30.0		1408	1275	1199	1085	894	628	285
J17/30	L6640-KP	40.0	30.0		1457	1319	1240	1122	925	650	295
J17/31	L6650-KP	50.0	37.0		1505	1363	1281	1159	956	671	305
J17/32	L6650-KP	50.0	37.0		1554	1407	1323	1197	987	693	315
J17/33	L6650-KP	50.0	37.0		1602	1451	1364	1234	1018	715	325
J17/34	L6650-KP	50.0	37.0		1651	1495	1406	1272	1049	736	335
J17/35	L6650-KP	50.0	37.0		1699	1539	1447	1309	1079	758	344
J17/36	L6650-KP	50.0	37.0		1748	1583	1488	1346	1110	780	354

Dimensions & weights of pump with Water filled motor

Type Pump + Motor	ØM [inch]	ØE [inch]	Length [inch]			Gross weight [lbs]			Gross volume [ft³]		
			L1	L		Pump	Pump+Motor		Pump	Pump+Motor	
				1 ~	3 ~		1 ~	3 ~		1 ~	3 ~
J17/27 + L6635-KP	5.59	5.59	59.09	-	100.55	74	-	304	1.3	-	5.6
J17/28 + L6640-KP	5.59	5.59	60.87	-	105.47	76	-	323	1.6	-	6.3
J17/29 + L6640-KP	5.59	5.59	62.64	-	107.24	77	-	324	1.6	-	6.3
J17/30 + L6640-KP	5.59	5.59	64.41	-	109.02	118	-	365	5.0	-	9.7
J17/31 + L6650-KP	5.59	5.59	66.18	-	112.76	128	-	401	5.1	-	9.8
J17/32 + L6650-KP	5.59	5.59	67.95	-	114.53	132	-	406	5.2	-	9.9
J17/33 + L6650-KP	5.59	5.59	69.72	-	116.30	137	-	410	5.4	-	10.1
J17/34 + L6650-KP	5.59	5.59	71.50	-	118.07	141	-	414	5.5	-	10.2
J17/35 + L6650-KP	5.59	5.59	73.27	-	119.84	147	-	420	5.6	-	10.3
J17/36 + L6650-KP	5.59	5.59	75.04	-	121.61	150	-	423	5.9	-	10.6

Note: ØE = For single cable motor maximum diameter of pump inclusive of cable guard.
For two cable motor maximum diameter of pump inclusive of cable guard will increase by 0.12 inch.

Rp 2 & Rp 3 are available on request.
All dimensions in inches unless otherwise noted.

Performance curves

Radial flow 6" stainless steel submersible bore well pumps

J17

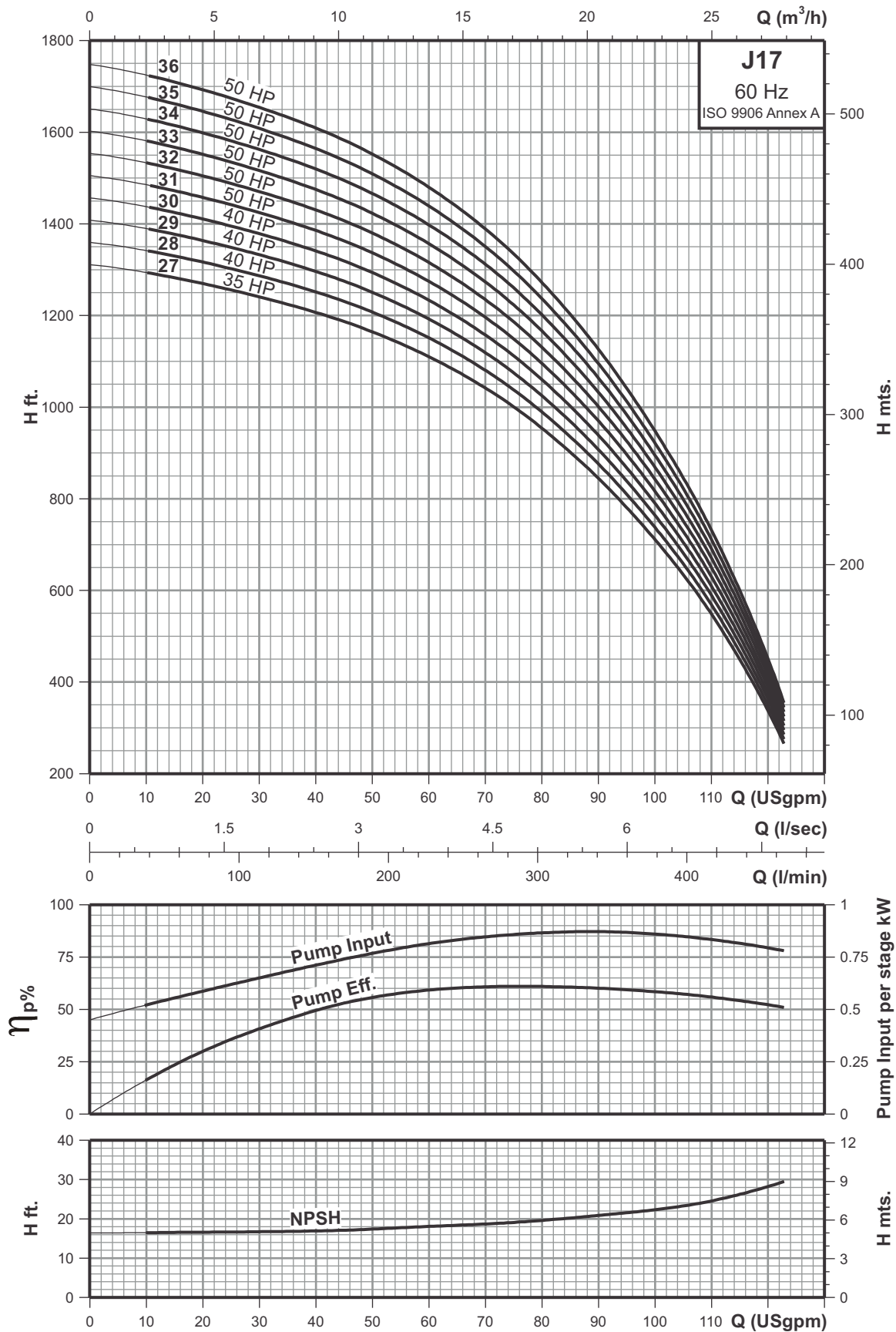

Technical data

Radial flow 6" stainless steel submersible bore well pumps

J17A

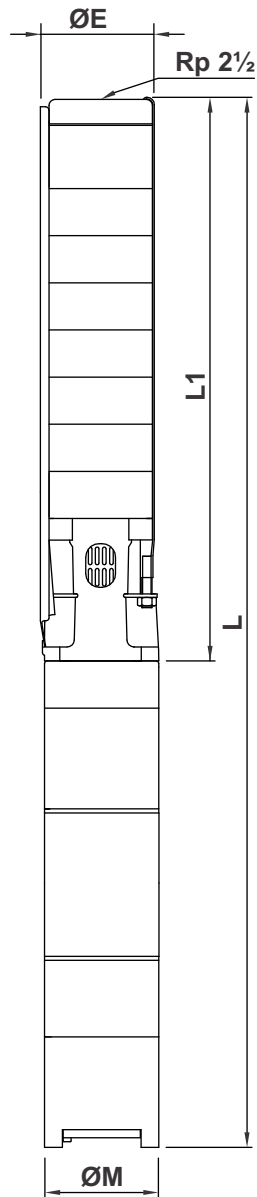

Performance chart

Pump type	Motor type		HP	kW	Q l/min USgpm	n = 3450 rpm						
	Oil filled	Water filled				0	231	284	341	390	454	511
						61	75	90	103	120	135	
J17A/3	H4640	L4640	4.00	3.00	H ft.	194	180	167	148	125	92	56
J17A/4	H4655	L4655	5.50	4.00		259	241	223	197	166	123	74
J17A/5	H4675	L4675	7.50	5.50		322	301	279	246	208	153	93
J17A/6	H46100	L6610-KP	10.0	7.50		389	361	335	295	249	184	112
J17A/7	H46100	L6610-KP	10.0	7.50		454	421	390	345	291	214	130
J17A/8	-	L6612-KP	12.5	9.30		517	481	446	394	333	245	149
J17A/9	-	L6612-KP	12.5	9.30		584	541	502	443	374	276	167
J17A/10	-	L6615-KP	15.0	11.0		653	602	558	492	416	306	186
J17A/11	-	L6615-KP	15.0	11.0		715	662	614	541	457	337	205
J17A/12	-	L6617-KP	17.5	13.0		781	722	669	591	499	368	223
J17A/13	-	L6620-KP	20.0	15.0		847	782	725	640	540	398	242
J17A/14	-	L6620-KP	20.0	15.0		909	842	781	689	582	429	260
J17A/15	-	L6625-KP	25.0	18.5		974	902	837	738	623	459	279
J17A/16	-	L6625-KP	25.0	18.5		1040	962	892	787	665	490	298
J17A/17	-	L6625-KP	25.0	18.5		1102	1023	948	837	707	521	316
J17A/18	-	L6625-KP	25.0	18.5		1168	1083	1004	886	748	551	335

Dimensions & weights of pump with Oil filled motor

Type Pump + Motor	$\varnothing M$ [inch]	$\varnothing E$ [inch]	Length [inch]			Gross weight [lbs]			Gross volume [ft ³]		
			L1	L		Pump	Pump+Motor		Pump	Pump+Motor	
				1 ~	3 ~		1 ~	3 ~		1 ~	3 ~
J17A/3 + H4640	3.74	5.59	16.61	-	38.86	20	-	62	0.8	-	1.2
J17A/4 + H4655	3.74	5.59	18.78	44.96	42.99	22	71	69	0.8	1.3	1.2
J17A/5 + H4675	3.74	5.59	20.94	-	47.13	24	-	79	0.8	-	1.3
J17A/6 + H46100	3.74	5.59	23.11	-	54.80	26	-	96	0.8	-	1.3
J17A/7 + H46100	3.74	5.59	25.28	-	56.97	29	-	99	0.8	-	1.3

Dimensions & weights of pump with Water filled motor

Type Pump + Motor	$\varnothing M$ [inch]	$\varnothing E$ [inch]	Length [inch]			Gross weight [lbs]			Gross volume [ft ³]		
			L1	L		Pump	Pump+Motor		Pump	Pump+Motor	
				1 ~	3 ~		1 ~	3 ~		1 ~	3 ~
J17A/3 + L4640	3.74	3.98	16.61	-	45.00	20	-	82	0.8	-	1.3
J17A/4 + L4655	3.74	3.98	18.78	51.89	51.10	22	88	95	0.8	1.3	1.3
J17A/5 + L4675	3.74	3.98	20.94	-	56.02	24	-	100	0.8	-	1.3
J17A/6 + L6610-KP	5.59	5.59	23.74	-	51.61	26	-	145	0.8	-	1.7
J17A/7 + L6610-KP	5.59	5.59	25.91	-	53.78	29	-	148	0.8	-	1.7
J17A/8 + L6612-KP	5.59	5.59	28.07	-	57.91	31	-	162	0.8	-	1.7
J17A/9 + L6612-KP	5.59	5.59	30.24	-	60.08	34	-	165	0.8	-	1.7
J17A/10 + L6615-KP	5.59	5.59	32.40	-	63.82	37	-	178	0.8	-	1.9
J17A/11 + L6615-KP	5.59	5.59	34.57	-	65.98	39	-	180	0.8	-	1.9
J17A/12 + L6617-KP	5.59	5.59	36.73	-	69.53	41	-	190	0.8	-	1.9
J17A/13 + L6620-KP	5.59	5.59	38.90	-	72.87	43	-	198	0.8	-	1.9
J17A/14 + L6620-KP	5.59	5.59	41.06	-	75.04	45	-	200	0.8	-	1.9
J17A/15 + L6625-KP	5.59	5.59	43.23	-	79.96	51	-	224	0.8	-	1.9
J17A/16 + L6625-KP	5.59	5.59	45.39	-	82.13	52	-	225	1.3	-	2.4
J17A/17 + L6625-KP	5.59	5.59	47.56	-	84.29	55	-	227	1.3	-	2.4
J17A/18 + L6625-KP	5.59	5.59	49.72	-	86.46	57	-	229	1.3	-	2.4

Note: $\varnothing E$ = For single cable motor maximum diameter of pump inclusive of cable guard.
For two cable motor maximum diameter of pump inclusive of cable guard will increase by 0.12 inch.

Rp 2 & Rp 3 are available on request.

All dimensions in inches unless otherwise noted.

Performance curves

Radial flow 6" stainless steel submersible bore well pumps

J17A

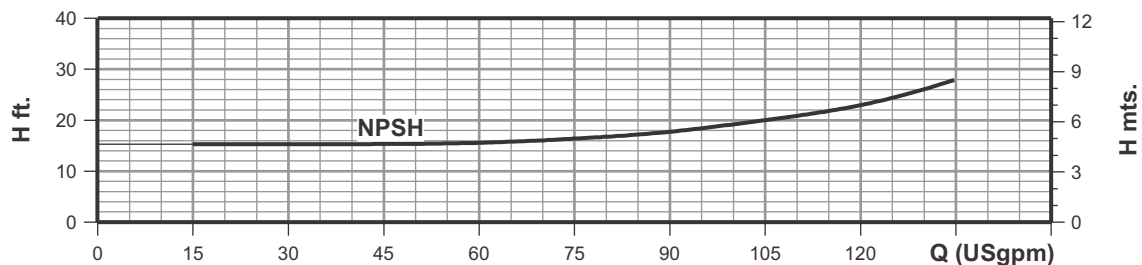
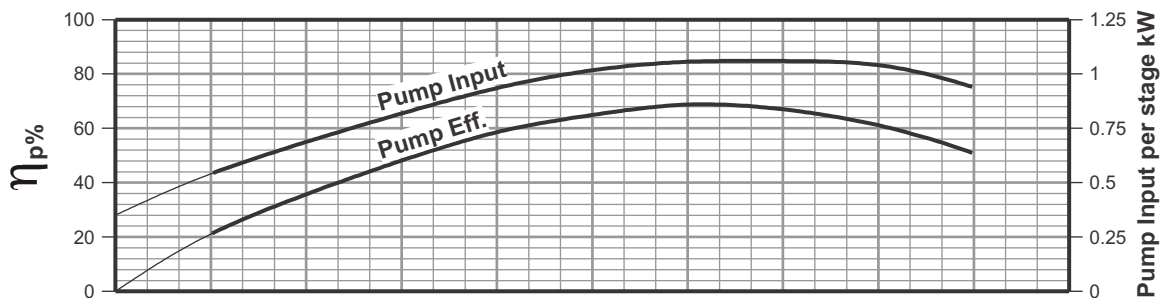
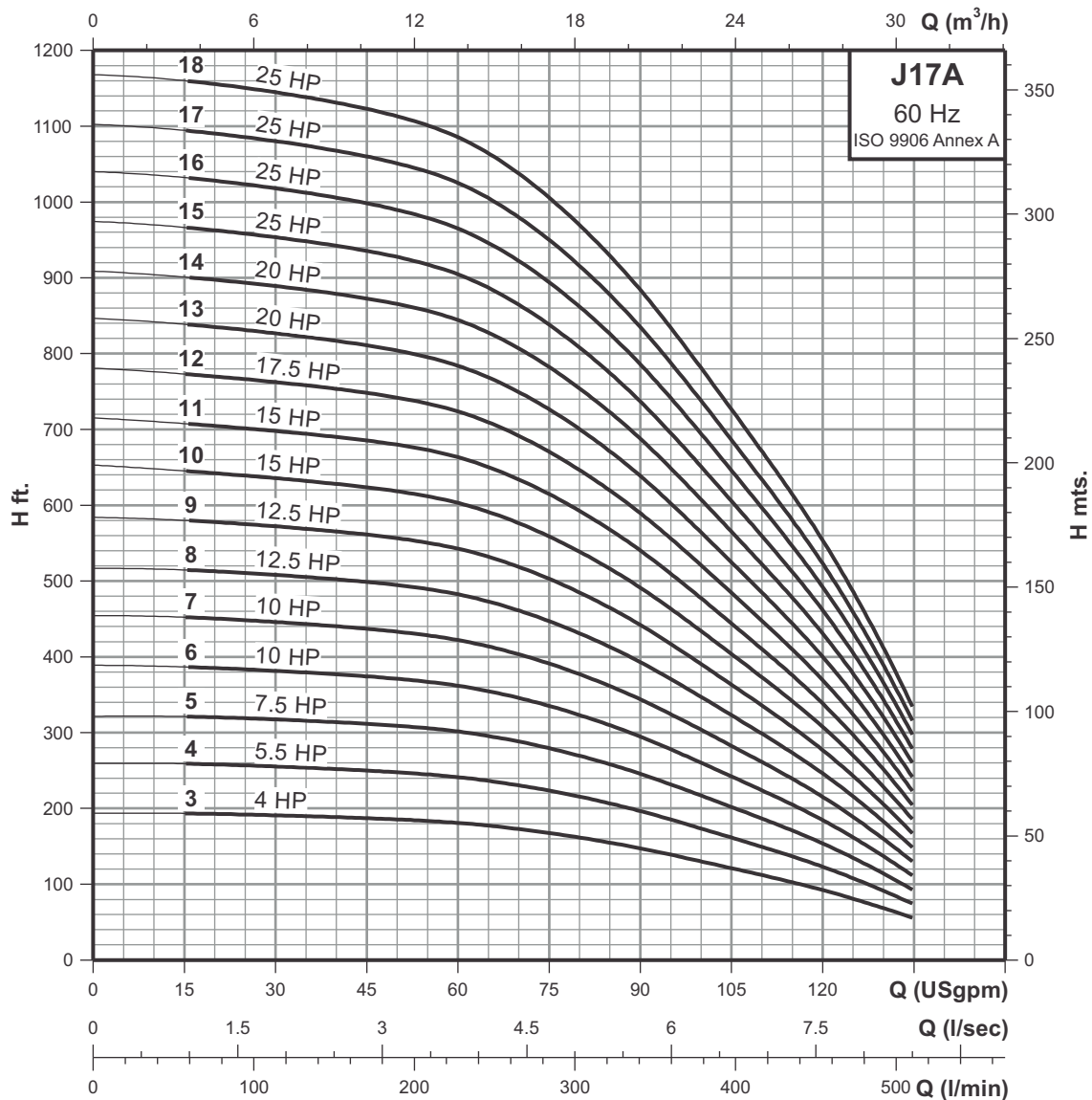

Technical data

Radial flow 6" stainless steel submersible bore well pumps

J17A

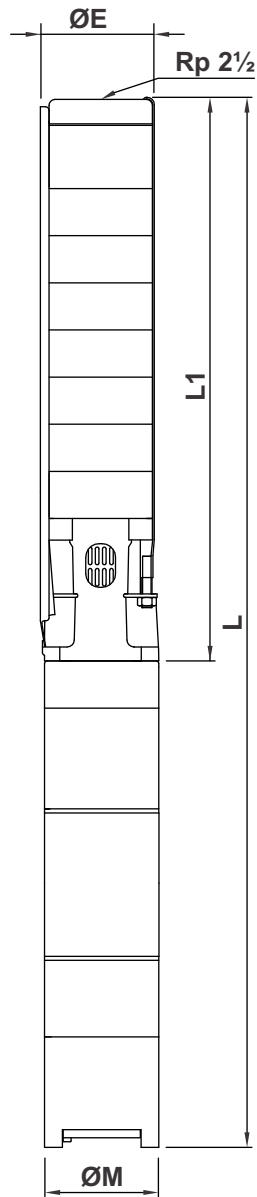

Performance chart

Pump type	Motor type	HP	kW	Q l/min	n = 3450 rpm						
					USgpm						
	Water filled	0	231	284	341	390	454	511			
J17A/19	L6630-KP	30.0	22.0	H ft.	1234	1143	1060	935	790	582	353
J17A/20	L6630-KP	30.0	22.0		1296	1203	1116	984	831	612	372
J17A/21	L6630-KP	30.0	22.0		1362	1263	1171	1034	873	643	390
J17A/22	L6630-KP	30.0	22.0		1427	1323	1227	1083	914	674	409
J17A/23	L6635-KP	35.0	26.0		1490	1383	1283	1132	956	704	428
J17A/24	L6635-KP	35.0	26.0		1555	1444	1339	1181	997	735	446
J17A/25	L6635-KP	35.0	26.0		1621	1504	1394	1230	1039	766	465
J17A/26	L6640-KP	40.0	30.0		1683	1564	1450	1280	1081	796	483
J17A/27	L6640-KP	40.0	30.0		1749	1624	1506	1329	1122	827	502
J17A/28	L6640-KP	40.0	30.0		1814	1684	1562	1378	1164	857	521
J17A/29	L6640-KP	40.0	30.0		1877	1744	1618	1427	1205	888	539
J17A/30	L6650-KP	50.0	37.0		1942	1805	1673	1476	1247	919	558
J17A/31	L6650-KP	50.0	37.0		2008	1865	1729	1526	1288	949	576
J17A/32	L6650-KP	50.0	37.0		2070	1925	1785	1575	1330	980	595
J17A/33	L6650-KP	50.0	37.0		2136	1985	1841	1624	1371	1011	614
J17A/34	L6650-KP	50.0	37.0		2201	2045	1896	1673	1413	1041	632

Dimensions & weights of pump with Water filled motor

Type Pump + Motor	$\varnothing M$ [inch]	$\varnothing E$ [inch]	Length [inch]			Gross weight [lbs]			Gross volume [ft ³]		
			L1	L		Pump	Pump+Motor		Pump	Pump+Motor	
				1 ~	3 ~		1 ~	3 ~		1 ~	3 ~
J17A/19 + L6630-KP	5.59	5.59	51.89	-	90.98	58	-	244	1.3	-	2.4
J17A/20 + L6630-KP	5.59	5.59	54.06	-	93.15	61	-	246	1.3	-	2.4
J17A/21 + L6630-KP	5.59	5.59	56.73	-	95.83	63	-	249	1.3	-	2.4
J17A/22 + L6630-KP	5.59	5.59	58.90	-	97.99	66	-	252	1.3	-	2.4
J17A/23 + L6635-KP	5.59	5.59	61.06	-	102.52	69	-	298	1.3	-	5.6
J17A/24 + L6635-KP	5.59	5.59	63.23	-	104.69	71	-	300	1.3	-	5.6
J17A/25 + L6635-KP	5.59	5.59	65.39	-	106.85	72	-	301	1.3	-	5.6
J17A/26 + L6640-KP	5.59	5.59	67.56	-	112.17	73	-	320	1.3	-	6.0
J17A/27 + L6640-KP	5.59	5.59	69.72	-	114.33	74	-	321	1.3	-	6.0
J17A/28 + L6640-KP	5.59	5.59	71.89	-	116.50	76	-	323	1.6	-	6.3
J17A/29 + L6640-KP	5.59	5.59	74.06	-	118.66	77	-	324	1.6	-	6.3
J17A/30 + L6650-KP	5.59	5.59	76.22	-	122.80	118	-	391	5.0	-	9.7
J17A/31 + L6650-KP	5.59	5.59	78.39	-	124.96	128	-	401	5.1	-	9.8
J17A/32 + L6650-KP	5.59	5.59	80.55	-	127.13	132	-	406	5.2	-	9.9
J17A/33 + L6650-KP	5.59	5.59	82.72	-	129.29	137	-	410	5.4	-	10.1
J17A/34 + L6650-KP	5.59	5.59	84.88	-	131.46	141	-	414	5.5	-	10.2

Note: $\varnothing E$ = For single cable motor maximum diameter of pump inclusive of cable guard.
 For two cable motor maximum diameter of pump inclusive of cable guard will increase by 0.12 inch.
 Rp 2 & Rp 3 are available on request.
 All dimensions in inches unless otherwise noted.

Performance curves

Radial flow 6" stainless steel submersible bore well pumps

J17A

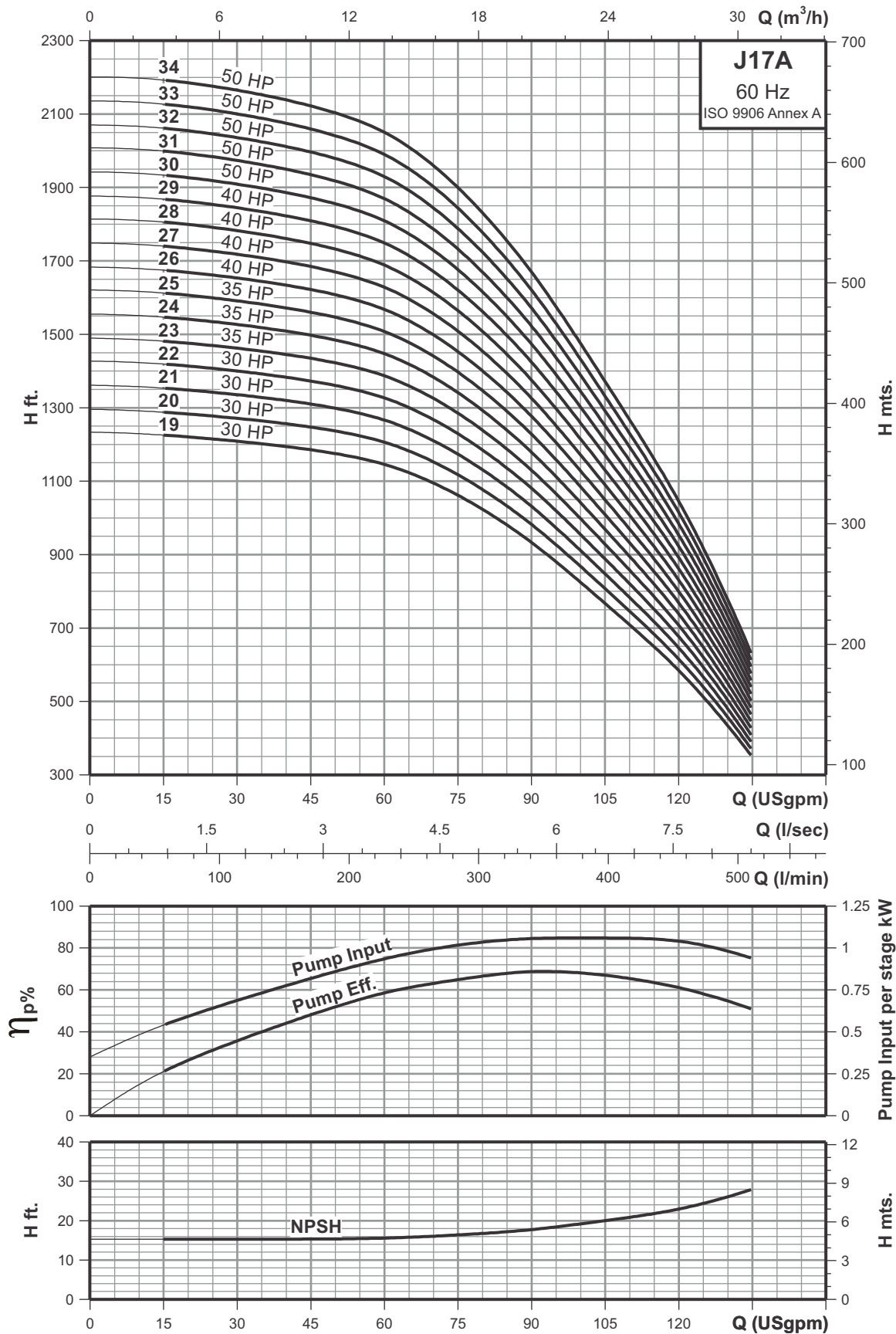

Technical data

Radial flow 6" stainless steel submersible bore well pumps

J20

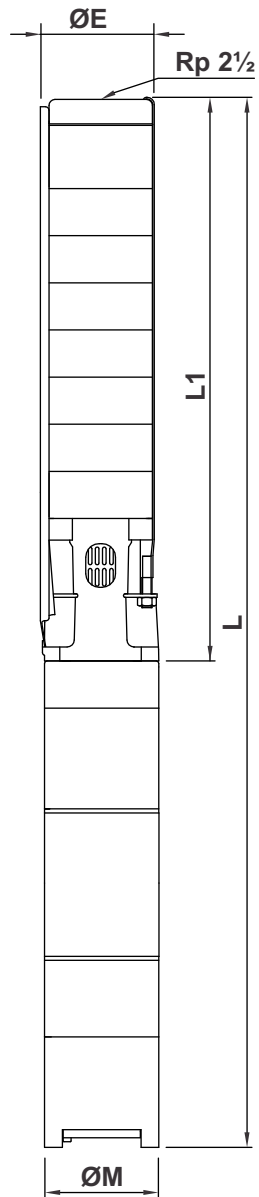

Performance chart

Pump type	Motor type		HP	kW	Q l/min USgpm	n = 3450 rpm						
	Oil filled	Water filled				0	246	352	408	477	528	582
						0	65	93	107.8	126	139.5	153.7
J20/4	H4675	L4675	7.50	5.50	H ft.	200	187	167	151	125	98	66
J20/5	H46100	L6610-KP	10.0	7.50		250	234	209	189	156	123	82
J20/6	-	L6612-KP	12.5	9.30		300	281	251	226	187	148	98
J20/7	-	L6612-KP	12.5	9.30		350	327	293	264	218	172	115
J20/8	-	L6615-KP	15.0	11.0		400	374	335	302	249	197	131
J20/9	-	L6617-KP	17.5	13.0		450	421	376	340	281	221	148
J20/10	-	L6617-KP	17.5	13.0		500	468	418	377	312	246	164
J20/11	-	L6620-KP	20.0	15.0		550	514	460	415	343	271	180
J20/12	-	L6625-KP	25.0	18.5		600	561	502	453	374	295	197
J20/13	-	L6625-KP	25.0	18.5		650	608	544	490	405	320	213
J20/14	-	L6625-KP	25.0	18.5		700	655	586	528	436	344	230
J20/15	-	L6630-KP	30.0	22.0		750	701	627	566	468	369	246
J20/16	-	L6630-KP	30.0	22.0		801	748	669	604	499	394	262
J20/17	-	L6630-KP	30.0	22.0		851	795	711	641	530	418	279
J20/18	-	L6635-KP	35.0	26.0		901	842	753	679	561	443	295
J20/19	-	L6635-KP	35.0	26.0		951	888	795	717	592	468	312
J20/20	-	L6635-KP	35.0	26.0		1001	935	837	755	623	492	328
J20/21	-	L6640-KP	40.0	30.0		1051	982	878	792	655	517	344
J20/22	-	L6640-KP	40.0	30.0		1101	1029	920	830	686	541	361
J20/23	-	L6640-KP	40.0	30.0		1151	1075	962	868	717	566	377
J20/24	-	L6650-KP	50.0	37.0		1201	1122	1004	906	748	591	394
J20/25	-	L6650-KP	50.0	37.0		1251	1169	1046	943	779	615	410
J20/26	-	L6650-KP	50.0	37.0		1301	1216	1088	981	810	640	427
J20/27	-	L6650-KP	50.0	37.0		1351	1262	1129	1019	842	664	443
J20/28	-	L6650-KP	50.0	37.0		1401	1309	1171	1056	873	689	459

Dimensions & weights of pump with Oil filled motor

Type Pump + Motor	ØM [inch]	ØE [inch]	Length [inch]			Gross weight [lbs]			Gross volume [ft³]		
			L1	L		Pump	Pump+Motor		Pump	Pump+Motor	
				1 ~	3 ~		1 ~	3 ~		1 ~	3 ~
J20/4 + H4675	3.74	5.59	18.78	-	44.96	22	-	76	0.8	-	1.3
J20/5 + H46100	3.74	5.59	20.94	-	52.64	24	-	94	0.8	-	1.3

Dimensions & weights of pump with Water filled motor

Type Pump + Motor	ØM [inch]	ØE [inch]	Length [inch]			Gross weight [lbs]			Gross volume [ft³]		
			L1	L		Pump	Pump+Motor		Pump	Pump+Motor	
				1 ~	3 ~		1 ~	3 ~		1 ~	3 ~
J20/4 + L4675	3.74	5.59	18.78	-	53.86	22	-	97	0.8	-	1.3
J20/5 + L6610-KP	5.59	5.59	21.57	-	49.45	24	-	144	0.8	-	1.7
J20/6 + L6612-KP	5.59	5.59	23.74	-	53.58	26	-	157	0.8	-	1.7
J20/7 + L6612-KP	5.59	5.59	25.91	-	55.75	29	-	160	0.8	-	1.7
J20/8 + L6615-KP	5.59	5.59	28.07	-	59.49	31	-	172	0.8	-	1.9
J20/9 + L6617-KP	5.59	5.59	30.24	-	63.03	34	-	184	0.8	-	1.9
J20/10 + L6617-KP	5.59	5.59	32.40	-	65.20	37	-	187	0.8	-	1.9
J20/11 + L6620-KP	5.59	5.59	34.57	-	68.54	39	-	194	0.8	-	1.9
J20/12 + L6625-KP	5.59	5.59	36.73	-	73.46	41	-	213	0.8	-	1.9
J20/13 + L6625-KP	5.59	5.59	38.90	-	75.63	43	-	215	0.8	-	1.9
J20/14 + L6625-KP	5.59	5.59	41.06	-	77.80	45	-	217	0.8	-	1.9
J20/15 + L6630-KP	5.59	5.59	43.23	-	82.32	51	-	237	0.8	-	1.9
J20/16 + L6630-KP	5.59	5.59	45.39	-	84.49	52	-	238	1.3	-	2.4
J20/17 + L6630-KP	5.59	5.59	47.56	-	86.65	55	-	241	1.3	-	2.4
J20/18 + L6635-KP	5.59	5.59	49.72	-	91.18	57	-	286	1.3	-	5.6
J20/19 + L6635-KP	5.59	5.59	51.89	-	93.35	58	-	288	1.3	-	5.6
J20/20 + L6635-KP	5.59	5.59	54.06	-	95.51	61	-	290	1.3	-	5.6
J20/21 + L6640-KP	5.59	5.59	56.73	-	101.34	63	-	310	1.3	-	6.0
J20/22 + L6640-KP	5.59	5.59	58.90	-	103.50	66	-	313	1.3	-	6.0
J20/23 + L6640-KP	5.59	5.59	61.06	-	105.67	69	-	315	1.3	-	6.0
J20/24 + L6650-KP	5.59	5.59	63.23	-	109.80	71	-	344	1.3	-	6.0
J20/25 + L6650-KP	5.59	5.59	65.39	-	111.97	72	-	345	1.3	-	6.0
J20/26 + L6650-KP	5.59	5.59	67.56	-	114.13	73	-	346	1.3	-	6.0
J20/27 + L6650-KP	5.59	5.59	69.72	-	116.30	74	-	348	1.3	-	6.0
J20/28 + L6650-KP	5.59	5.59	71.89	-	118.46	76	-	349	1.6	-	6.3

Note: ØE = For single cable motor maximum diameter of pump inclusive of cable guard.
 For two cable motor maximum diameter of pump inclusive of cable guard will increase by 0.12 inch.

Rp 2 & Rp 3 are available on request.
 All dimensions in inches unless otherwise noted.



Performance curves

Radial flow 6" stainless steel submersible bore well pumps

J20

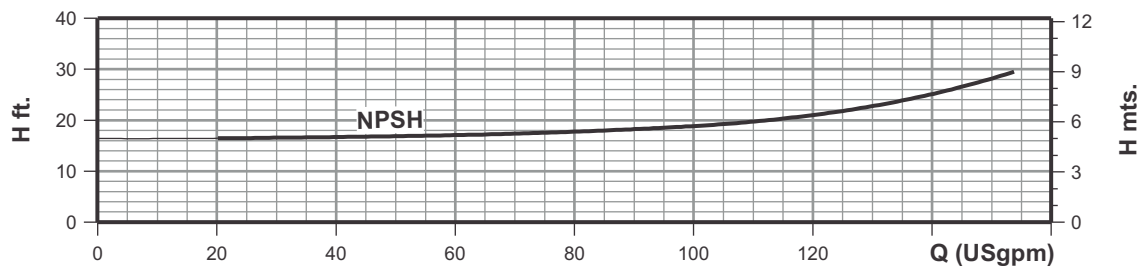
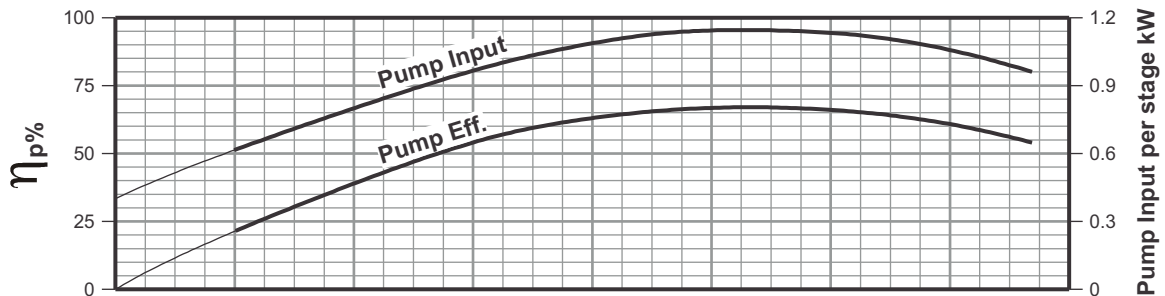
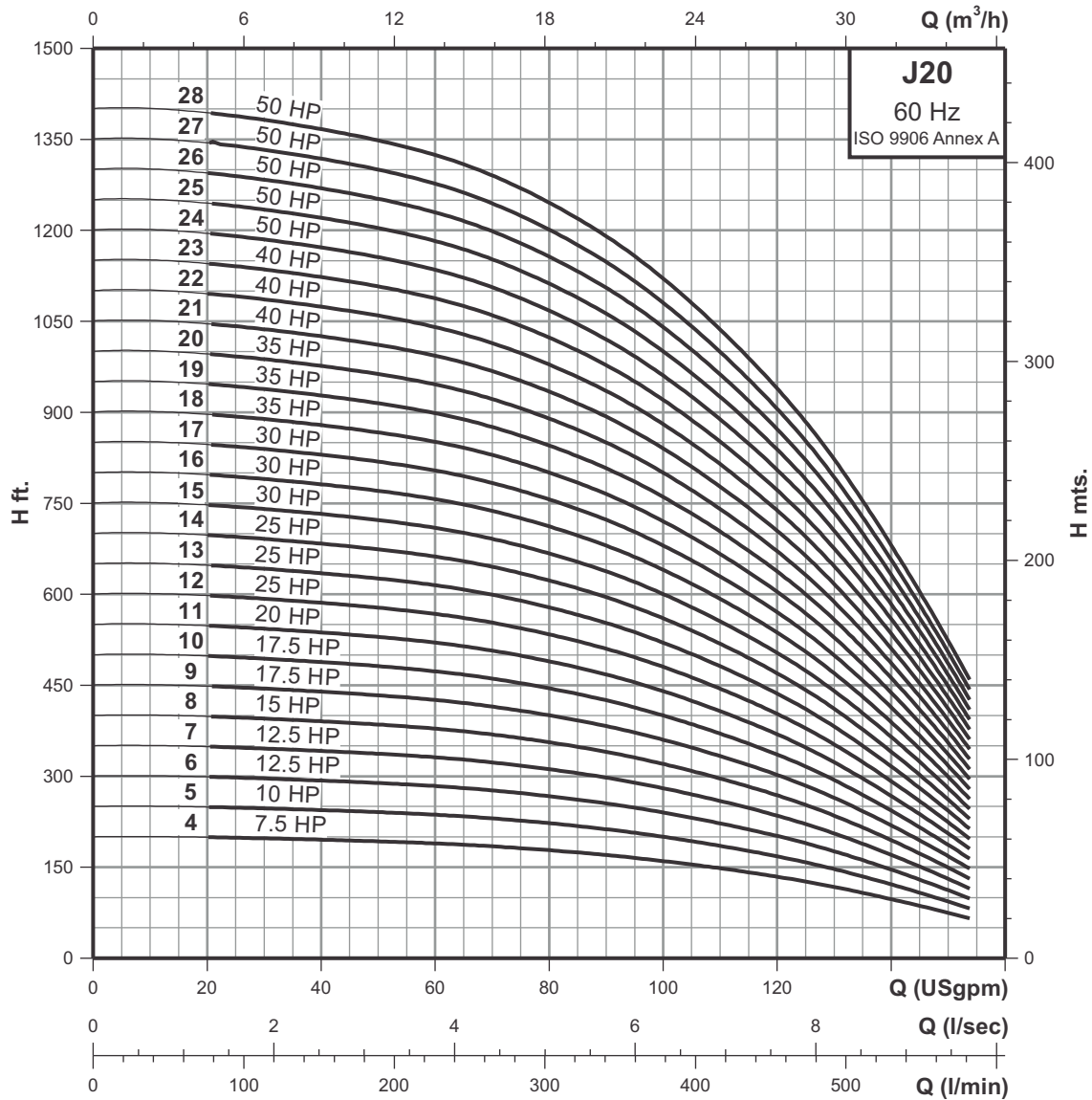

Technical data

Radial flow 6" stainless steel submersible bore well pumps

J20

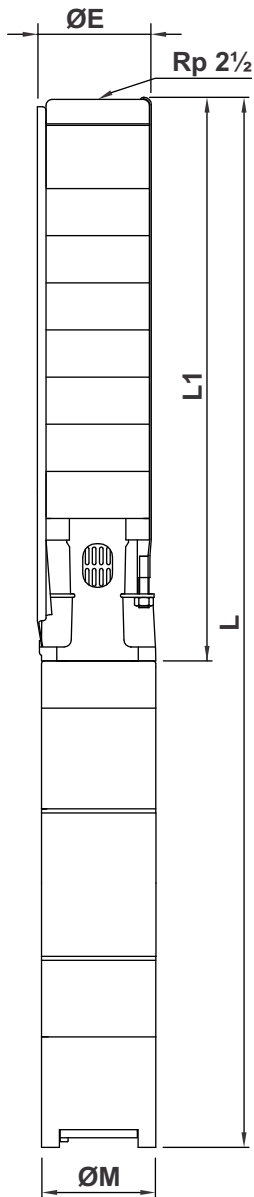

Performance chart

Pump type	Motor type	HP	kW	Q l/min	n = 3450 rpm						
					Water filled						
	USgpm	0	246	352	408	477	528	582			
J20/29	L6650-KP	50.0	37.0	H ft.	1451	1356	1213	1094	904	714	476
J20/30	L6650-KP	50.0	37.0		1501	1403	1255	1132	935	738	492
J20/31	L8660-KH	60.0	45.0		1551	1449	1297	1170	966	763	509
J20/32	L8660-KH	60.0	45.0		1601	1496	1339	1207	997	787	525
J20/33	L8660-KH	60.0	45.0		1651	1543	1380	1245	1029	812	541
J20/34	L8660-KH	60.0	45.0		1701	1590	1422	1283	1060	837	558
J20/35	L8660-KH	60.0	45.0		1751	1636	1464	1321	1091	861	574
J20/36	L8675-KH	75.0	55.0		1801	1683	1506	1358	1122	886	591

Dimensions & weights of pump with Water filled motor

Type Pump + Motor	ØM [inch]	ØE [inch]	Length [inch]			Gross weight [lbs]			Gross volume [ft ³]		
			L1	L		Pump	Pump+Motor		Pump	Pump+Motor	
				1 ~	3 ~		1 ~	3 ~		1 ~	3 ~
J20/29 + L6650-KP	5.59	5.59	74.06	-	120.63	77	-	350	1.6	-	6.3
J20/30 + L6650-KP	5.59	5.59	76.22	-	122.80	118	-	391	5.0	-	9.7
J20/31 + L8660-KH	7.48	7.48	81.50	-	129.21	128	-	600	5.1	-	12.6
J20/32 + L8660-KH	7.48	7.48	83.66	-	131.38	132	-	604	5.2	-	12.8
J20/33 + L8660-KH	7.48	7.48	85.83	-	133.54	137	-	608	5.4	-	12.9
J20/34 + L8660-KH	7.48	7.48	87.99	-	135.71	141	-	613	5.5	-	13.0
J20/35 + L8660-KH	7.48	7.48	90.16	-	137.87	147	-	618	5.6	-	13.2
J20/36 + L8675-KH	7.48	7.48	92.32	-	142.01	150	-	653	5.9	-	13.7

Note: ØE = For single cable motor maximum diameter of pump inclusive of cable guard.
For two cable motor maximum diameter of pump inclusive of cable guard will increase by 0.12 inch.

Rp 2 & Rp 3 are available on request.

All dimensions in inches unless otherwise noted.

Performance curves

Radial flow 6" stainless steel submersible bore well pumps

J20

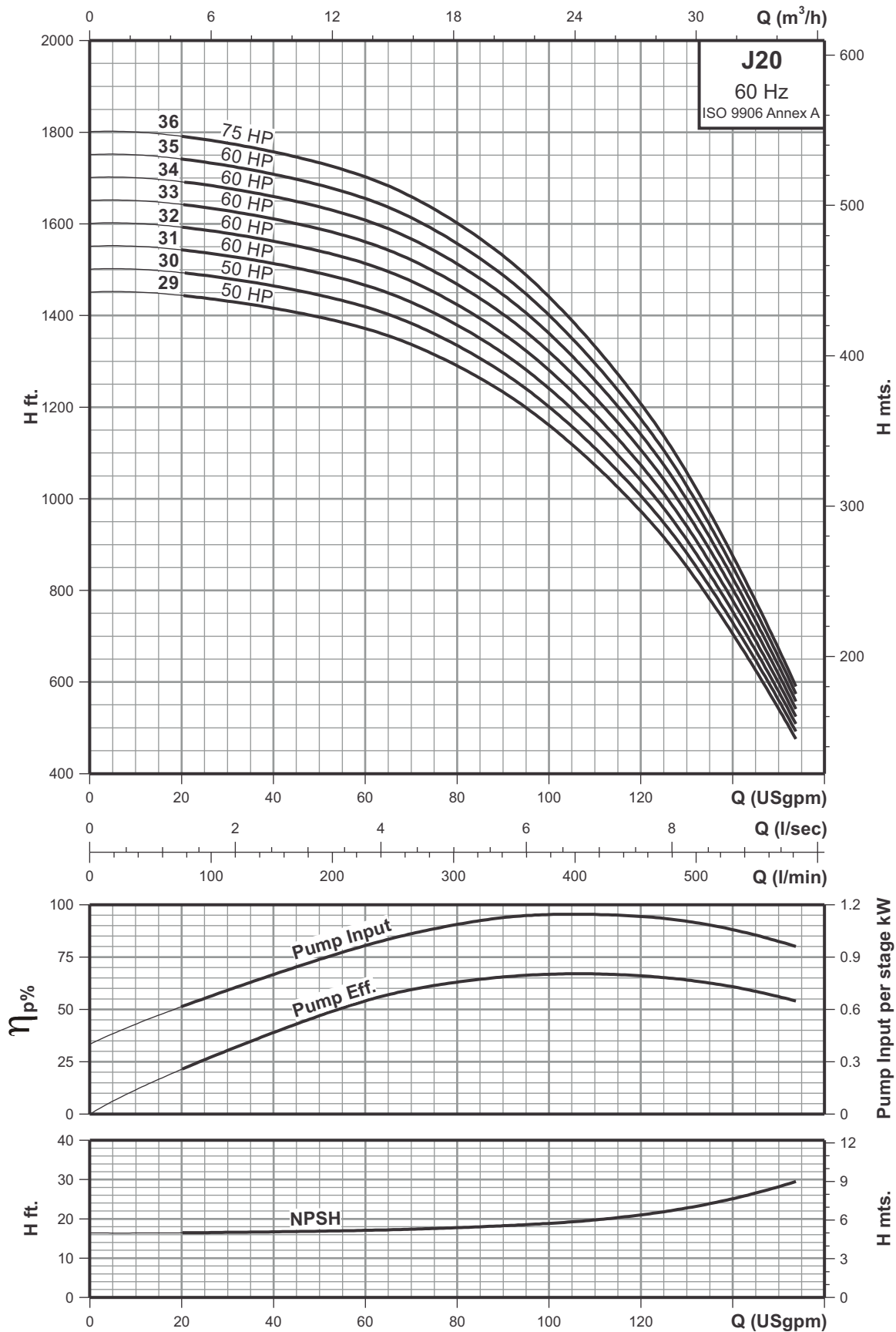

Technical data

Radial flow 6" stainless steel submersible bore well pumps

J24

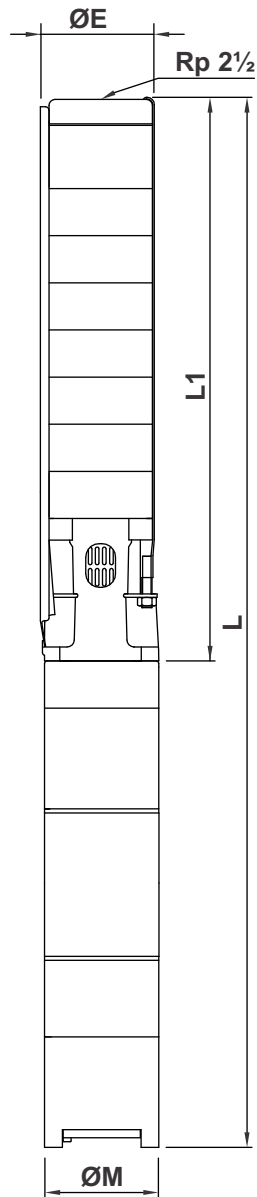

Performance chart

Pump type	Motor type		HP	kW	Q l/min USgpm	n = 3450 rpm						
	Oil filled	Water filled				0	379	408	488	552	617	700
						0	100	107.8	129	145.8	163	184.9
J24/3	H4675	L4675	7.50	5.50	H ft.	157	125	121	112	98	79	39
J24/4	H46100	L6610-KP	10.0	7.50		210	166	162	149	131	105	52
J24/5	-	L6612-KP	12.5	9.30		262	208	202	186	164	131	66
J24/6	-	L6612-KP	12.5	9.30		315	249	243	223	197	157	79
J24/7	-	L6615-KP	15.0	11.0		367	291	283	260	230	184	92
J24/8	-	L6617-KP	17.5	13.0		420	332	324	297	262	210	105
J24/9	-	L6620-KP	20.0	15.0		472	374	364	335	295	236	118
J24/10	-	L6625-KP	25.0	18.5		525	416	405	372	328	262	131
J24/11	-	L6625-KP	25.0	18.5		577	457	445	409	361	289	144
J24/12	-	L6625-KP	25.0	18.5		630	499	486	446	394	315	157
J24/13	-	L6630-KP	30.0	22.0		682	540	526	483	427	341	171
J24/14	-	L6630-KP	30.0	22.0		735	582	566	521	459	367	184
J24/15	-	L6635-KP	35.0	26.0		787	623	607	558	492	394	197
J24/16	-	L6635-KP	35.0	26.0		840	665	647	595	525	420	210
J24/17	-	L6640-KP	40.0	30.0		892	706	688	632	558	446	223
J24/18	-	L6640-KP	40.0	30.0		945	748	728	669	591	472	236
J24/19	-	L6640-KP	40.0	30.0		997	790	769	706	623	499	249
J24/20	-	L6650-KP	50.0	37.0		1050	831	809	744	656	525	262
J24/21	-	L6650-KP	50.0	37.0		1102	873	850	781	689	551	276
J24/22	-	L6650-KP	50.0	37.0		1155	914	890	818	722	577	289
J24/23	-	L6650-KP	50.0	37.0		1207	956	931	855	755	604	302
J24/24	-	L6650-KP	50.0	37.0		1260	997	971	892	787	630	315
J24/25	-	L8660-KH	60.0	45.0		1312	1039	1012	930	820	656	328
J24/26	-	L8660-KH	60.0	45.0		1365	1080	1052	967	853	682	341

Dimensions & weights of pump with Oil filled motor

Type Pump + Motor	ØM [inch]	ØE [inch]	Length [inch]		Gross weight [lbs]			Gross volume [ft³]			
			L1	L		Pump	Pump+Motor		Pump	Pump+Motor	
				1 ~	3 ~		1 ~	3 ~		1 ~	3 ~
J24/3 + H4675	3.74	5.59	15.35	-	41.54	20	-	75	0.8	-	1.3
J24/4 + H46100	3.74	5.59	18.15	-	49.84	22	-	91	0.8	-	1.3

Dimensions & weights of pump with Water filled motor

Type Pump + Motor	ØM [inch]	ØE [inch]	Length [inch]		Gross weight [lbs]			Gross volume [ft³]			
			L1	L		Pump	Pump+Motor		Pump	Pump+Motor	
				1 ~	3 ~		1 ~	3 ~		1 ~	3 ~
J24/3 + L4675	3.74	5.59	15.35	-	50.43	20	-	95	0.8	-	1.3
J24/4 + L6610-KP	5.59	5.59	18.78	-	46.65	22	-	141	0.8	-	1.7
J24/5 + L6612-KP	5.59	5.59	21.57	-	51.42	24	-	155	0.8	-	1.7
J24/6 + L6612-KP	5.59	5.59	23.74	-	53.58	26	-	157	0.8	-	1.7
J24/7 + L6615-KP	5.59	5.59	25.91	-	57.32	29	-	169	0.8	-	1.9
J24/8 + L6617-KP	5.59	5.59	28.07	-	60.87	31	-	181	0.8	-	1.9
J24/9 + L6620-KP	5.59	5.59	30.24	-	64.21	34	-	189	0.8	-	1.9
J24/10 + L6625-KP	5.59	5.59	32.40	-	69.13	37	-	210	0.8	-	1.9
J24/11 + L6625-KP	5.59	5.59	34.57	-	71.30	39	-	212	0.8	-	1.9
J24/12 + L6625-KP	5.59	5.59	36.73	-	73.46	41	-	213	0.8	-	1.9
J24/13 + L6630-KP	5.59	5.59	38.90	-	77.99	43	-	228	0.8	-	1.9
J24/14 + L6630-KP	5.59	5.59	41.06	-	80.16	45	-	231	0.8	-	1.9
J24/15 + L6635-KP	5.59	5.59	43.23	-	84.69	51	-	280	0.8	-	5.2
J24/16 + L6635-KP	5.59	5.59	45.39	-	86.85	52	-	282	1.3	-	5.6
J24/17 + L6640-KP	5.59	5.59	47.56	-	92.17	55	-	302	1.3	-	6.0
J24/18 + L6640-KP	5.59	5.59	49.72	-	94.33	57	-	304	1.3	-	6.0
J24/19 + L6640-KP	5.59	5.59	51.89	-	96.50	58	-	305	1.3	-	6.0
J24/20 + L6650-KP	5.59	5.59	54.06	-	100.63	61	-	334	1.3	-	6.0
J24/21 + L6650-KP	5.59	5.59	56.73	-	103.31	63	-	336	1.3	-	6.0
J24/22 + L6650-KP	5.59	5.59	58.90	-	105.47	66	-	340	1.3	-	6.0
J24/23 + L6650-KP	5.59	5.59	61.06	-	107.64	69	-	342	1.3	-	6.0
J24/24 + L6650-KP	5.59	5.59	63.23	-	109.80	71	-	344	1.3	-	6.0
J24/25 + L8660-KH	7.48	7.48	68.50	-	116.22	72	-	544	1.3	-	8.8
J24/26 + L8660-KH	7.48	7.48	70.67	-	118.39	73	-	545	1.3	-	8.8

Note: ØE = For single cable motor maximum diameter of pump inclusive of cable guard.
For two cable motor maximum diameter of pump inclusive of cable guard will increase by 0.12 inch.

Rp 2 & Rp 3 are available on request.
All dimensions in inches unless otherwise noted.

Performance curves

Radial flow 6" stainless steel submersible bore well pumps

J24

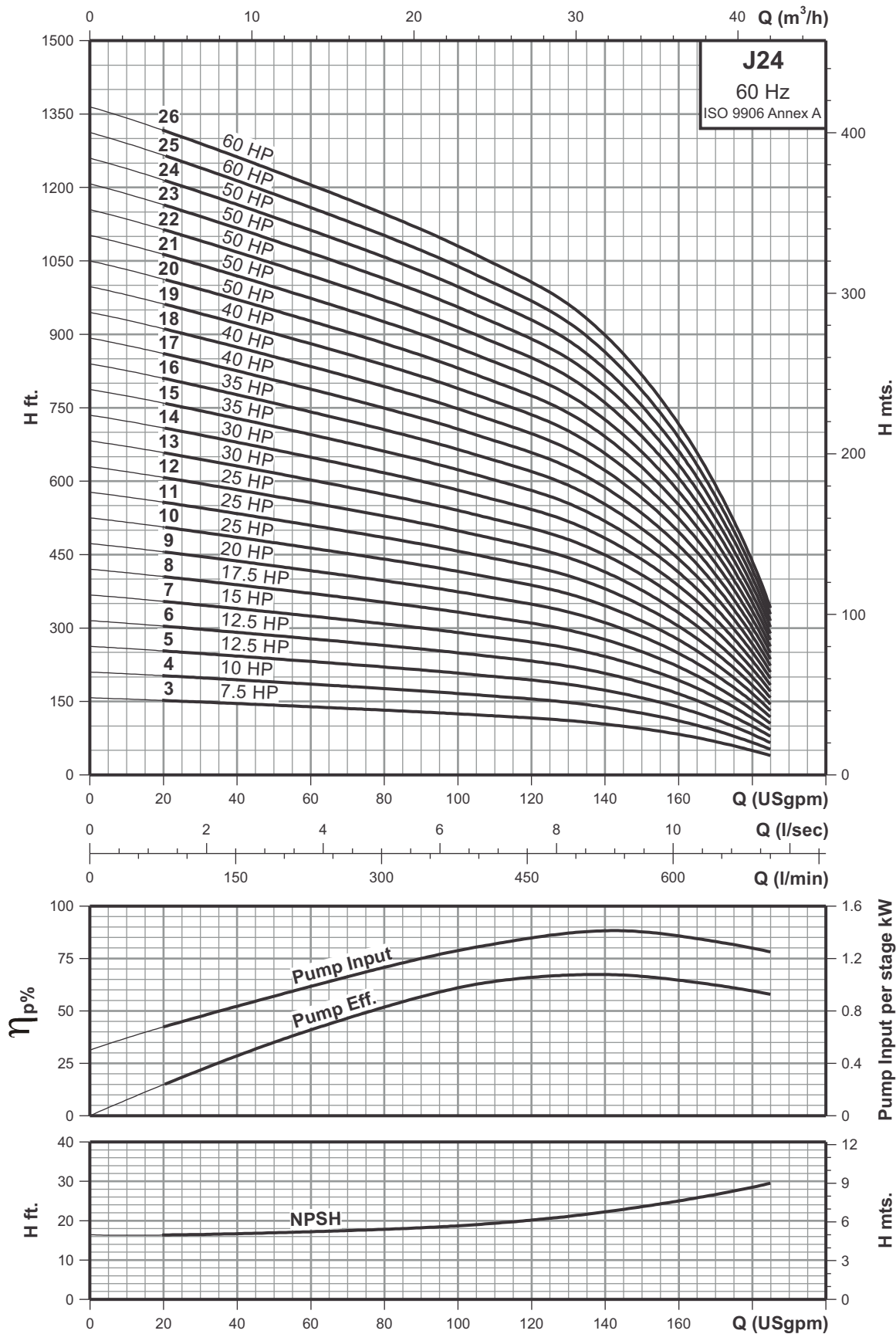

Technical data

Radial flow 6" stainless steel submersible bore well pumps

J24

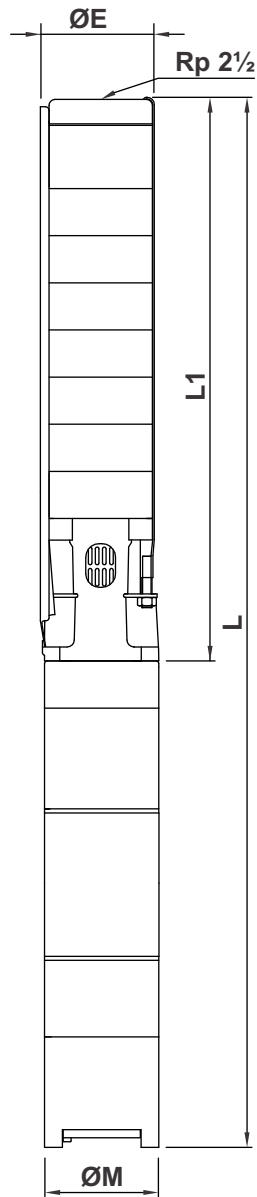

Performance chart

Pump type	Motor type	HP	kW	Q	n = 3450 rpm						
					l/min	0	379	408	488	552	617
	Water filled	USgpm	0	100	107.8	129	145.8	163	184.9		
J24/27	L8660-KH	60.0	45.0	H ft.	1417	1122	1093	1004	886	709	354
J24/28	L8660-KH	60.0	45.0		1470	1164	1133	1041	919	735	367
J24/29	L8660-KH	60.0	45.0		1522	1205	1173	1078	951	761	381
J24/30	L8660-KH	60.0	45.0		1575	1247	1214	1115	984	787	394
J24/31	L8675-KH	75.0	55.0		1627	1288	1254	1153	1017	814	407
J24/32	L8675-KH	75.0	55.0		1680	1330	1295	1190	1050	840	420
J24/33	L8675-KH	75.0	55.0		1732	1371	1335	1227	1083	866	433
J24/34	L8675-KH	75.0	55.0		1785	1413	1376	1264	1115	892	446
J24/35	L8675-KH	75.0	55.0		1837	1455	1416	1301	1148	919	459
J24/36	L8675-KH	75.0	55.0		1890	1496	1457	1339	1181	945	472

Dimensions & weights of pump with Water filled motor

Type Pump + Motor	ØM [inch]	ØE [inch]	Length [inch]			Gross weight [lbs]			Gross volume [ft³]		
			L1	L		Pump	Pump+Motor		Pump	Pump+Motor	
				1 ~	3 ~		1 ~	3 ~		1 ~	3 ~
J24/27 + L8660-KH	7.48	7.48	72.83	-	120.55	74	-	546	1.3	-	8.8
J24/28 + L8660-KH	7.48	7.48	75.00	-	122.72	76	-	547	1.6	-	9.1
J24/29 + L8660-KH	7.48	7.48	77.17	-	124.88	77	-	549	1.6	-	9.1
J24/30 + L8660-KH	7.48	7.48	79.33	-	127.05	118	-	590	5.0	-	12.5
J24/31 + L8675-KH	7.48	7.48	81.50	-	131.18	128	-	631	5.1	-	12.9
J24/32 + L8675-KH	7.48	7.48	83.66	-	133.35	132	-	635	5.2	-	13.0
J24/33 + L8675-KH	7.48	7.48	85.83	-	135.51	137	-	639	5.4	-	13.2
J24/34 + L8675-KH	7.48	7.48	87.99	-	137.68	141	-	644	5.5	-	13.3
J24/35 + L8675-KH	7.48	7.48	90.16	-	139.84	147	-	649	5.6	-	13.4
J24/36 + L8675-KH	7.48	7.48	92.32	-	142.01	150	-	653	5.9	-	13.7

Note: ØE = For single cable motor maximum diameter of pump inclusive of cable guard.
For two cable motor maximum diameter of pump inclusive of cable guard will increase by 0.12 inch.

Rp 2 & Rp 3 are available on request.

All dimensions in inches unless otherwise noted.

Performance curves

Radial flow 6" stainless steel submersible bore well pumps

J24

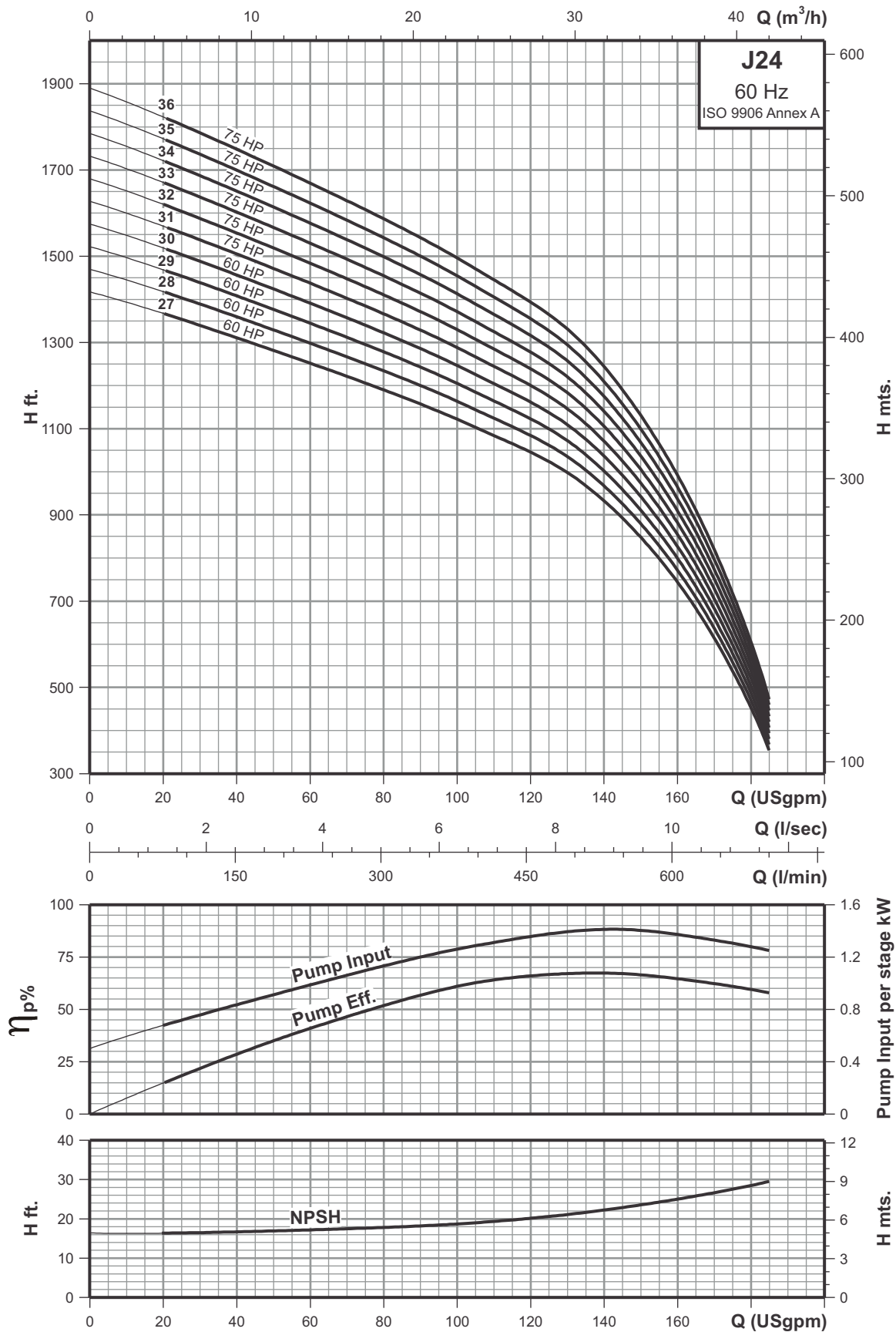

Technical data

Radial flow 6" stainless steel submersible bore well pumps

J13H

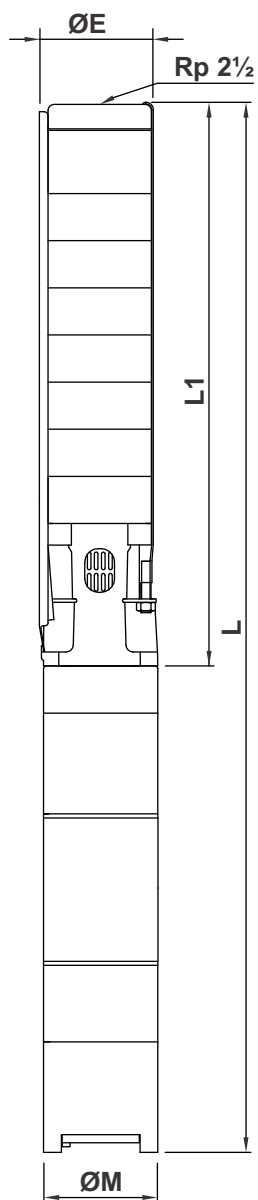

Performance chart

Pump type	Motor type		HP	kW	Q l/min USgpm	n = 3450 rpm						
	Oil filled	Water filled				0	95	174	240	325	365	420
J13H/2	H4640	L4640	4.00	3.00	H ft.	134	131	125	115	89	69	26
J13H/3	H4655	L4655	5.50	4.00		202	197	187	172	133	103	39
J13H/4	H4675	L4675	7.50	5.50		269	262	249	230	177	138	52
J13H/5	H46100	L6610-KP	10.0	7.50		336	328	312	287	221	172	66
J13H/6	-	L6612-KP	12.5	9.30		403	394	374	344	266	207	79
J13H/7	-	L6612-KP	12.5	9.30		471	459	436	402	310	241	92
J13H/8	-	L6612-KP	12.5	9.30		538	525	499	459	354	276	105
J13H/9	-	L6615-KP	15.0	11.0		605	590	561	517	399	310	118
J13H/10	-	L6617-KP	17.5	13.0		672	656	623	574	443	344	131
J13H/11	-	L6617-KP	17.5	13.0		740	722	686	631	487	379	144
J13H/12	-	L6620-KP	20.0	15.0		807	787	748	689	531	413	157
J13H/13	-	L6620-KP	20.0	15.0		874	853	810	746	576	448	171
J13H/14	-	L6625-KP	25.0	18.5		941	918	872	804	620	482	184
J13H/15	-	L6625-KP	25.0	18.5		1009	984	935	861	664	517	197
J13H/16	-	L6625-KP	25.0	18.5		1076	1050	997	918	708	551	210
J13H/17	-	L6630-KP	30.0	22.0		1143	1115	1059	976	753	585	223
J13H/18	-	L6630-KP	30.0	22.0		1210	1181	1122	1033	797	620	236
J13H/19	-	L6630-KP	30.0	22.0		1278	1246	1184	1091	841	654	249
J13H/20	-	L6635-KP	35.0	26.0		1345	1312	1246	1148	886	689	262
J13H/21	-	L6635-KP	35.0	26.0		1412	1378	1309	1205	930	723	276
J13H/22	-	L6635-KP	35.0	26.0		1479	1443	1371	1263	974	758	289
J13H/23	-	L6640-KP	40.0	30.0		1547	1509	1433	1320	1018	792	302
J13H/24	-	L6640-KP	40.0	30.0		1614	1574	1496	1378	1063	827	315
J13H/25	-	L6640-KP	40.0	30.0		1681	1640	1558	1435	1107	861	328
J13H/26	-	L6640-KP	40.0	30.0		1748	1706	1620	1492	1151	895	341
J13H/27	-	L6650-KP	50.0	37.0		1815	1771	1683	1550	1196	930	354
J13H/28	-	L6650-KP	50.0	37.0		1883	1837	1745	1607	1240	964	367
J13H/29	-	L6650-KP	50.0	37.0		1950	1902	1807	1665	1284	999	380
J13H/30	-	L6650-KP	50.0	37.0		2017	1968	1870	1722	1328	1033	394

Dimensions & weights of pump with Oil filled motor

Type Pump + Motor	ØM [inch]	ØE [inch]	Length [inch]			Gross weight [lbs]			Gross volume [ft³]		
			L1	L		Pump	Pump+Motor		Pump	Pump+Motor	
				1 ~	3 ~		1 ~	3 ~		1 ~	3 ~
J13H/2 + H4640	3.74	5.63	14.49	-	36.73	14	-	57	0.9	-	1.4
J13H/3 + H4655	3.74	5.63	16.26	42.44	40.47	17	67	65	0.9	1.5	1.4
J13H/4 + H4675	3.74	5.63	18.03	-	44.21	22	-	77	0.9	-	1.5
J13H/5 + H46100	3.74	5.63	19.80	-	51.50	27	-	97	0.9	-	1.5

Dimensions & weights of pump with Water filled motor

Type Pump + Motor	ØM [inch]	ØE [inch]	Length [inch]			Gross weight [lbs]			Gross volume [ft³]		
			L1	L		Pump	Pump+Motor		Pump	Pump+Motor	
				1 ~	3 ~		1 ~	3 ~		1 ~	3 ~
J13H/2 + L4640	3.74	5.63	14.49	-	42.87	14	-	76	0.9	-	1.5
J13H/3 + L4655	3.74	5.63	16.26	49.37	48.58	17	84	91	0.9	1.5	1.5
J13H/4 + L4675	3.74	5.63	18.03	-	53.11	22	-	98	0.9	-	1.5
J13H/5 + L6610-KP	5.59	5.63	20.43	-	48.31	27	-	146	0.9	-	1.8
J13H/6 + L6612-KP	5.59	5.63	22.20	-	52.05	32	-	163	0.9	-	1.8
J13H/7 + L6612-KP	5.59	5.63	23.98	-	53.82	37	-	168	0.9	-	1.8
J13H/8 + L6612-KP	5.59	5.63	25.75	-	55.59	42	-	173	0.9	-	1.8
J13H/9 + L6615-KP	5.59	5.63	27.52	-	58.94	46	-	186	0.9	-	2.0
J13H/10 + L6617-KP	5.59	5.63	29.29	-	62.09	51	-	201	0.9	-	2.0
J13H/11 + L6617-KP	5.59	5.63	31.06	-	63.86	56	-	205	0.9	-	2.0
J13H/12 + L6620-KP	5.59	5.63	32.83	-	66.81	61	-	216	0.9	-	2.0
J13H/13 + L6620-KP	5.59	5.63	34.61	-	68.58	65	-	220	0.9	-	2.0
J13H/14 + L6625-KP	5.59	5.63	36.38	-	73.11	69	-	241	1.5	-	2.5
J13H/15 + L6625-KP	5.59	5.63	38.15	-	74.88	76	-	248	1.5	-	2.5
J13H/16 + L6625-KP	5.59	5.63	39.92	-	76.65	80	-	252	1.5	-	2.5
J13H/17 + L6630-KP	5.59	5.63	41.69	-	80.79	84	-	270	1.5	-	2.5
J13H/18 + L6630-KP	5.59	5.63	43.46	-	82.56	89	-	275	1.5	-	2.5
J13H/19 + L6630-KP	5.59	5.63	45.24	-	84.33	93	-	279	1.5	-	2.5
J13H/20 + L6635-KP	5.59	5.63	47.01	-	88.46	100	-	329	1.5	-	5.8
J13H/21 + L6635-KP	5.59	5.63	48.78	-	90.24	104	-	333	1.5	-	5.8
J13H/22 + L6635-KP	5.59	5.63	50.55	-	92.01	110	-	339	1.5	-	5.8
J13H/23 + L6640-KP	5.59	5.63	52.32	-	96.93	115	-	362	1.5	-	6.2
J13H/24 + L6640-KP	5.59	5.63	54.09	-	98.70	119	-	366	1.5	-	6.2
J13H/25 + L6640-KP	5.59	5.63	55.87	-	100.47	124	-	371	1.5	-	6.2
J13H/26 + L6640-KP	5.59	5.63	57.64	-	102.24	129	-	376	1.8	-	6.5
J13H/27 + L6650-KP	5.59	5.63	59.41	-	105.98	133	-	406	1.8	-	6.5
J13H/28 + L6650-KP	5.59	5.63	61.18	-	107.76	139	-	412	1.8	-	6.5
J13H/29 + L6650-KP	5.59	5.63	62.95	-	109.53	141	-	415	1.8	-	6.5
J13H/30 + L6650-KP	5.59	5.63	64.72	-	111.30	146	-	420	1.8	-	6.5

Note: ØE = For single cable motor maximum diameter of pump inclusive of cable guard.
 For two cable motor maximum diameter of pump inclusive of cable guard will increase by 0.12 inch.
 Rp 2 & Rp 3 are available on request.
 Add -T subscript to motor type for 4" Oil filled and Water filled 3 ~ motor.
 All dimensions in inches unless otherwise noted.



Performance curves

Radial flow 6" stainless steel submersible bore well pumps

J13H

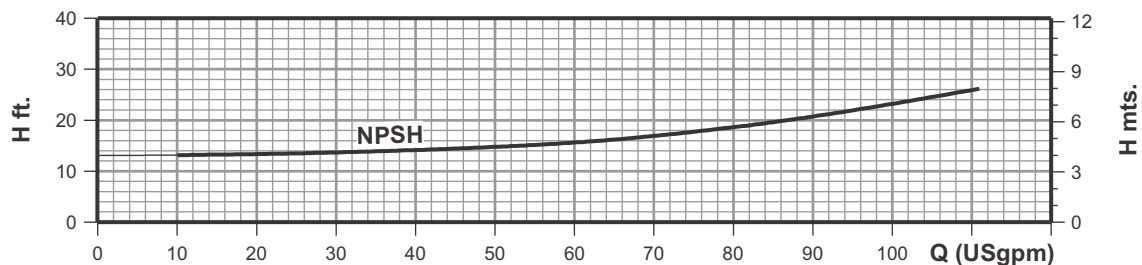
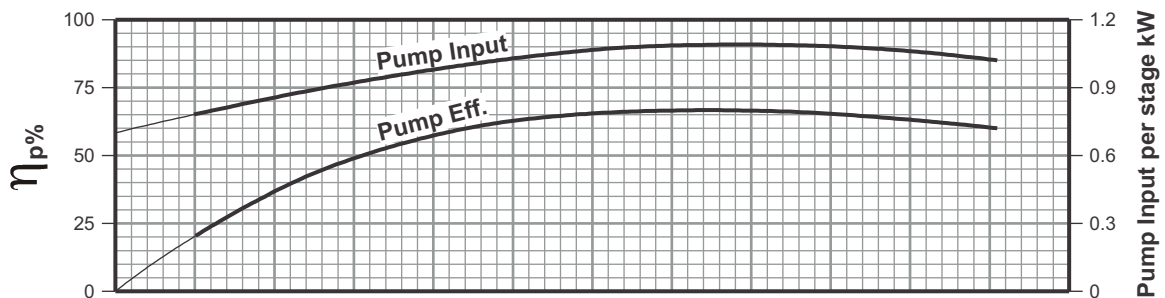
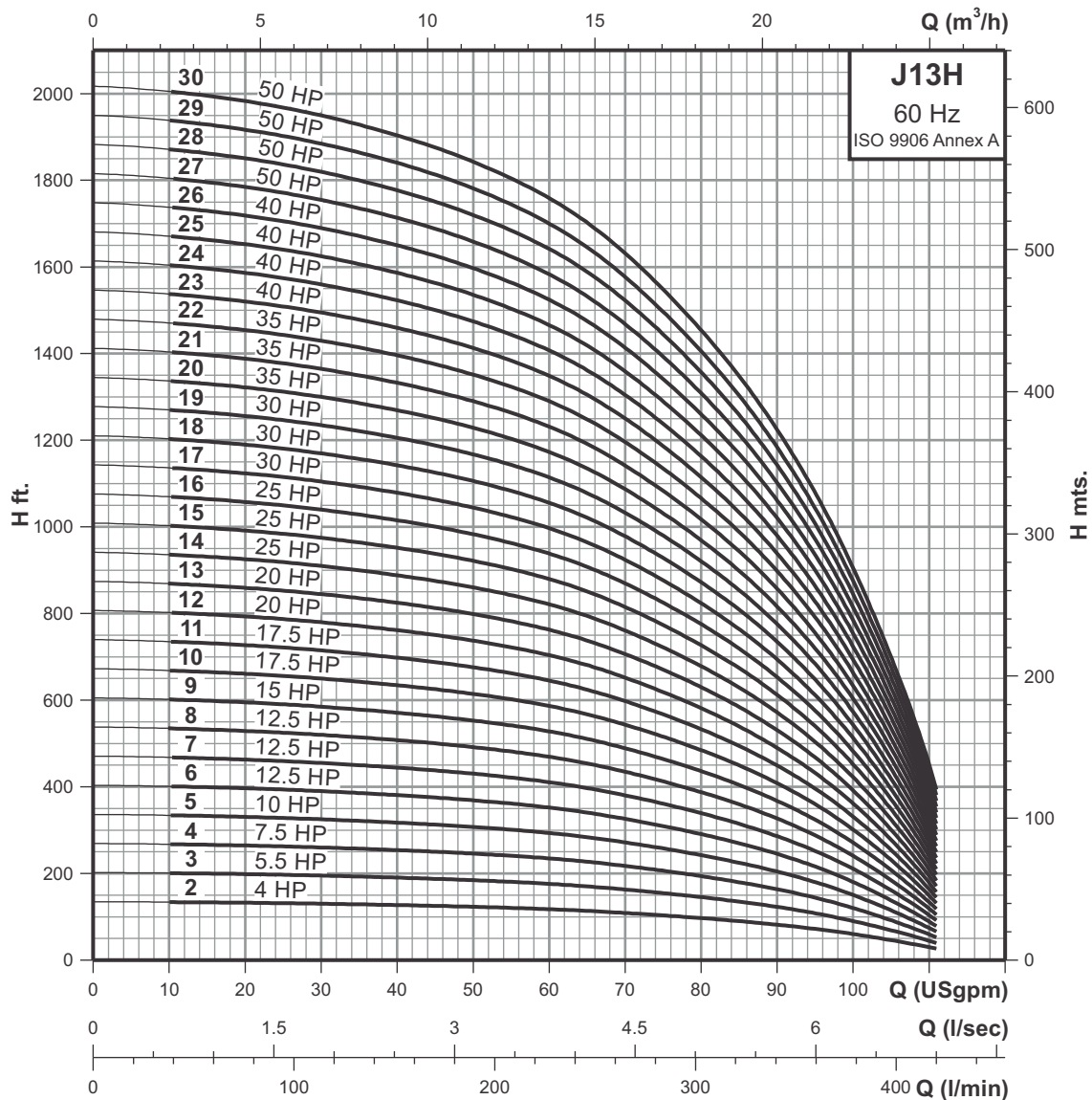

Technical data

Radial flow 6" stainless steel submersible bore well pumps

J16H

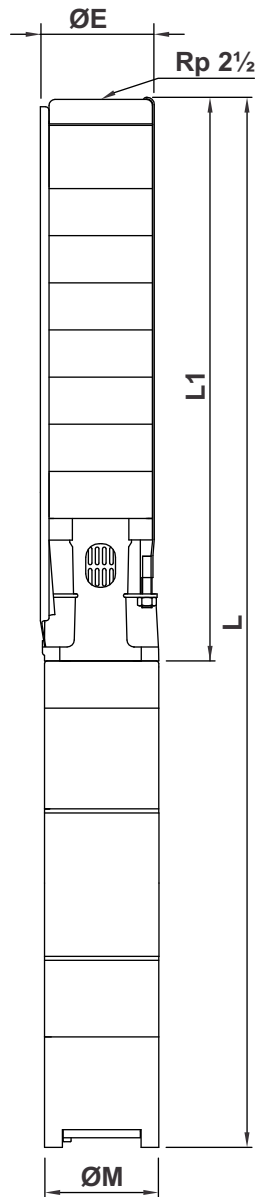

Performance chart

Pump type	Motor type		HP	kW	Q l/min USgpm	n = 3450 rpm						
	Oil filled	Water filled				0	100	160	242	333	358	420
						0	26.4	42.3	64	88	94.7	111
J16H/3	H4655	L4655	5.50	4.00	H ft.	207	197	187	167	138	128	98
J16H/4	H4675	L4675	7.50	5.50		276	262	249	223	184	171	131
J16H/5	H46100	L6610-KP	10.0	7.50		344	328	312	279	230	213	164
J16H/6	H46100	L6610-KP	10.0	7.50		413	394	374	335	276	256	197
J16H/7	-	L6612-KP	12.5	9.30		482	459	436	390	321	298	230
J16H/8	-	L6615-KP	15.0	11.0		551	525	499	446	367	341	262
J16H/9	-	L6617-KP	17.5	13.0		620	590	561	502	413	384	295
J16H/10	-	L6617-KP	17.5	13.0		689	656	623	558	459	426	328
J16H/11	-	L6620-KP	20.0	15.0		758	722	686	613	505	469	361
J16H/12	-	L6625-KP	25.0	18.5		827	787	748	669	551	512	394
J16H/13	-	L6625-KP	25.0	18.5		895	853	810	725	597	554	426
J16H/14	-	L6625-KP	25.0	18.5		964	918	872	781	643	597	459
J16H/15	-	L6630-KP	30.0	22.0		1033	984	935	836	689	640	492
J16H/16	-	L6630-KP	30.0	22.0		1102	1050	997	892	735	682	525
J16H/17	-	L6630-KP	30.0	22.0		1171	1115	1059	948	781	725	558
J16H/18	-	L6635-KP	35.0	26.0		1240	1181	1122	1004	827	768	590
J16H/19	-	L6635-KP	35.0	26.0		1309	1246	1184	1059	872	810	623
J16H/20	-	L6635-KP	35.0	26.0		1378	1312	1246	1115	918	853	656
J16H/21	-	L6640-KP	40.0	30.0		1446	1378	1309	1171	964	895	689
J16H/22	-	L6640-KP	40.0	30.0		1515	1443	1371	1227	1010	938	722
J16H/23	-	L6640-KP	40.0	30.0		1584	1509	1433	1282	1056	981	754
J16H/24	-	L6650-KP	50.0	37.0		1653	1574	1496	1338	1102	1023	787
J16H/25	-	L6650-KP	50.0	37.0		1722	1640	1558	1394	1148	1066	820
J16H/26	-	L6650-KP	50.0	37.0		1791	1706	1620	1450	1194	1109	853
J16H/27	-	L6650-KP	50.0	37.0		1860	1771	1683	1506	1240	1151	886
J16H/28	-	L6650-KP	50.0	37.0		1929	1837	1745	1561	1286	1194	918
J16H/29	-	L6650-KP	50.0	37.0		1998	1902	1807	1617	1332	1237	951
J16H/30	-	L6650-KP	50.0	37.0		2066	1968	1870	1673	1378	1279	984

Dimensions & weights of pump with Oil filled motor

Type Pump + Motor	ØM [inch]	ØE [inch]	Length [inch]			Gross weight [lbs]			Gross volume [ft³]		
			L1	L		Pump	Pump+Motor		Pump	Pump+Motor	
				1 ~	3 ~		1 ~	3 ~		1 ~	3 ~
J16H/3 + H4655	3.74	5.63	16.26	42.44	40.47	17	67	65	0.9	1.5	1.4
J16H/4 + H4675	3.74	5.63	18.03	-	44.21	22	-	77	0.9	-	1.5
J16H/5 + H46100	3.74	5.63	19.80	-	51.50	27	-	97	0.9	-	1.5
J16H/6 + H46100	3.74	5.63	21.57	-	53.27	32	-	102	0.9	-	1.5

Dimensions & weights of pump with Water filled motor

Type Pump + Motor	ØM [inch]	ØE [inch]	Length [inch]			Gross weight [lbs]			Gross volume [ft³]		
			L1	L		Pump	Pump+Motor		Pump	Pump+Motor	
				1 ~	3 ~		1 ~	3 ~		1 ~	3 ~
J16H/3 + L4655	3.74	5.63	16.26	49.37	48.58	17	84	91	0.9	1.5	1.5
J16H/4 + L4675	3.74	5.63	18.03	-	53.11	22	-	98	0.9	-	1.5
J16H/5 + L6610-KP	5.59	5.63	20.43	-	48.31	27	-	146	0.9	-	1.8
J16H/6 + L6610-KP	5.59	5.63	22.20	-	50.08	32	-	151	0.9	-	1.8
J16H/7 + L6612-KP	5.59	5.63	23.98	-	53.82	37	-	168	0.9	-	1.8
J16H/8 + L6615-KP	5.59	5.63	25.75	-	57.17	42	-	182	0.9	-	2.0
J16H/9 + L6617-KP	5.59	5.63	27.52	-	60.31	46	-	196	0.9	-	2.0
J16H/10 + L6617-KP	5.59	5.63	29.29	-	62.09	51	-	201	0.9	-	2.0
J16H/11 + L6620-KP	5.59	5.63	31.06	-	65.04	56	-	211	0.9	-	2.0
J16H/12 + L6625-KP	5.59	5.63	32.83	-	69.57	61	-	233	0.9	-	2.0
J16H/13 + L6625-KP	5.59	5.63	34.61	-	71.34	65	-	237	0.9	-	2.0
J16H/14 + L6625-KP	5.59	5.63	36.38	-	73.11	69	-	241	1.5	-	2.5
J16H/15 + L6630-KP	5.59	5.63	38.15	-	77.24	76	-	261	1.5	-	2.5
J16H/16 + L6630-KP	5.59	5.63	39.92	-	79.02	80	-	266	1.5	-	2.5
J16H/17 + L6630-KP	5.59	5.63	41.69	-	80.79	84	-	270	1.5	-	2.5
J16H/18 + L6635-KP	5.59	5.63	43.46	-	84.92	89	-	319	1.5	-	5.8
J16H/19 + L6635-KP	5.59	5.63	45.24	-	86.69	93	-	323	1.5	-	5.8
J16H/20 + L6635-KP	5.59	5.63	47.01	-	88.46	100	-	329	1.5	-	5.8
J16H/21 + L6640-KP	5.59	5.63	48.78	-	93.39	104	-	351	1.5	-	6.2
J16H/22 + L6640-KP	5.59	5.63	50.55	-	95.16	110	-	356	1.5	-	6.2
J16H/23 + L6640-KP	5.59	5.63	52.32	-	96.93	115	-	362	1.5	-	6.2
J16H/24 + L6650-KP	5.59	5.63	54.09	-	100.67	119	-	393	1.5	-	6.2
J16H/25 + L6650-KP	5.59	5.63	55.87	-	102.44	124	-	397	1.5	-	6.2
J16H/26 + L6650-KP	5.59	5.63	57.64	-	104.21	129	-	402	1.8	-	6.5
J16H/27 + L6650-KP	5.59	5.63	59.41	-	105.98	133	-	406	1.8	-	6.5
J16H/28 + L6650-KP	5.59	5.63	61.18	-	107.76	139	-	412	1.8	-	6.5
J16H/29 + L6650-KP	5.59	5.63	62.95	-	109.53	144	-	418	1.8	-	6.5
J16H/30 + L6650-KP	5.59	5.63	64.72	-	111.30	150	-	423	1.8	-	6.5

Note: ØE = For single cable motor maximum diameter of pump inclusive of cable guard.

For two cable motor maximum diameter of pump inclusive of cable guard will increase by 0.12 inch.

Rp 2 & Rp 3 are available on request.

Add -T subscript to motor type for 4" Oil filled and Water filled 3 ~ motor.

All dimensions in inches unless otherwise noted.

Performance curves

Radial flow 6" stainless steel submersible bore well pumps

J16H

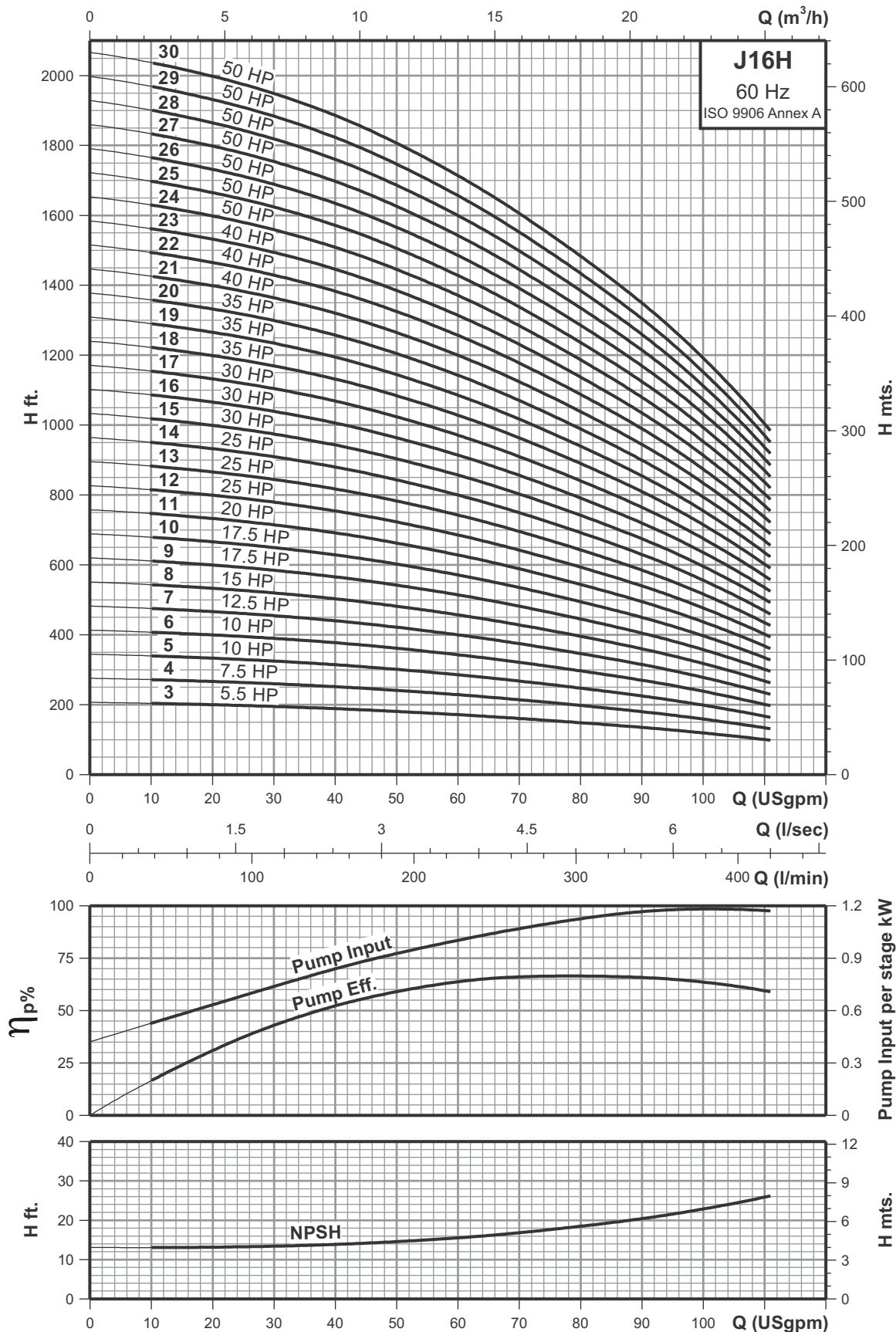

Technical data

Radial flow 6" stainless steel submersible bore well pumps

J18H

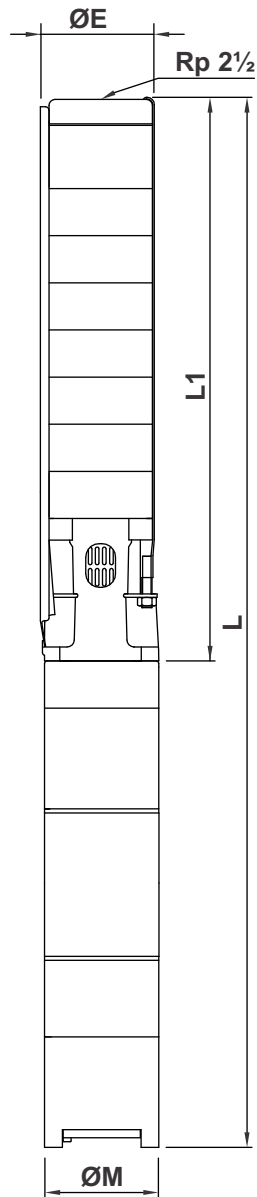

Performance chart

Pump type	Motor type		HP	kW	Q l/min USgpm	n = 3450 rpm						
	Oil filled	Water filled				0	197	254	300	360	440	520
						0	52	67	79.3	95.1	116.2	137.4
J18H/3	H4675	L4675	7.50	5.50	H ft.	216	197	187	177	157	118	59
J18H/4	H46100	L6610-KP	10.0	7.50		289	262	249	236	210	157	79
J18H/5	H46100	L6610-KP	10.0	7.50		361	328	312	295	262	197	98
J18H/6	-	L6612-KP	12.5	9.30		433	394	374	354	315	236	118
J18H/7	-	L6615-KP	15.0	11.0		505	459	436	413	367	276	138
J18H/8	-	L6617-KP	17.5	13.0		577	525	499	472	420	315	157
J18H/9	-	L6620-KP	20.0	15.0		649	590	561	531	472	354	177
J18H/10	-	L6625-KP	25.0	18.5		722	656	623	590	525	394	197
J18H/11	-	L6625-KP	25.0	18.5		794	722	686	649	577	433	216
J18H/12	-	L6625-KP	25.0	18.5		866	787	748	708	630	472	236
J18H/13	-	L6630-KP	30.0	22.0		938	853	810	768	682	512	256
J18H/14	-	L6630-KP	30.0	22.0		1010	918	872	827	735	551	276
J18H/15	-	L6635-KP	35.0	26.0		1082	984	935	886	787	590	295
J18H/16	-	L6635-KP	35.0	26.0		1155	1050	997	945	840	630	315
J18H/17	-	L6635-KP	35.0	26.0		1227	1115	1059	1004	892	669	335
J18H/18	-	L6640-KP	40.0	30.0		1299	1181	1122	1063	945	708	354
J18H/19	-	L6640-KP	40.0	30.0		1371	1246	1184	1122	997	748	374
J18H/20	-	L6650-KP	50.0	37.0		1443	1312	1246	1181	1050	787	394
J18H/21	-	L6650-KP	50.0	37.0		1515	1378	1309	1240	1102	827	413
J18H/22	-	L6650-KP	50.0	37.0		1588	1443	1371	1299	1155	866	433
J18H/23	-	L6650-KP	50.0	37.0		1660	1509	1433	1358	1207	905	453
J18H/24	-	L6650-KP	50.0	37.0		1732	1574	1496	1417	1260	945	472
J18H/25	-	L8660-KH	60.0	45.0		1804	1640	1558	1476	1312	984	492
J18H/26	-	L8660-KH	60.0	45.0		1876	1706	1620	1535	1364	1023	512
J18H/27	-	L8660-KH	60.0	45.0		1948	1771	1683	1594	1417	1063	531
J18H/28	-	L8660-KH	60.0	45.0		2020	1837	1745	1653	1469	1102	551
J18H/29	-	L8660-KH	60.0	45.0		2093	1902	1807	1712	1522	1141	571
J18H/30	-	L8675-KH	75.0	55.0		2165	1968	1870	1771	1574	1181	590

Dimensions & weights of pump with Oil filled motor

Type Pump + Motor	ØM [inch]	ØE [inch]	Length [inch]			Gross weight [lbs]			Gross volume [ft³]		
			L1	L		Pump	Pump+Motor		Pump	Pump+Motor	
				1 ~	3 ~		1 ~	3 ~		1 ~	3 ~
J18H/3 + H4675	3.74	5.63	16.26	-	42.44	17	-	72	0.9	-	1.5
J18H/4 + H46100	3.74	5.63	18.03	-	49.72	22	-	92	0.9	-	1.5
J18H/5 + H46100	3.74	5.63	19.80	-	51.50	27	-	97	0.9	-	1.5

Dimensions & weights of pump with Water filled motor

Type Pump + Motor	ØM [inch]	ØE [inch]	Length [inch]			Gross weight [lbs]			Gross volume [ft³]		
			L1	L		Pump	Pump+Motor		Pump	Pump+Motor	
				1 ~	3 ~		1 ~	3 ~		1 ~	3 ~
J18H/3 + L4675	3.74	5.63	16.26	-	51.34	17	-	93	0.9	-	1.5
J18H/4 + L6610-KP	5.59	5.63	18.66	-	46.54	22	-	142	0.9	-	1.8
J18H/5 + L6610-KP	5.59	5.63	20.43	-	48.31	27	-	146	0.9	-	1.8
J18H/6 + L6612-KP	5.59	5.63	22.20	-	52.05	32	-	163	0.9	-	1.8
J18H/7 + L6615-KP	5.59	5.63	23.98	-	55.39	37	-	177	0.9	-	2.0
J18H/8 + L6617-KP	5.59	5.63	25.75	-	58.54	42	-	191	0.9	-	2.0
J18H/9 + L6620-KP	5.59	5.63	27.52	-	61.50	46	-	201	0.9	-	2.0
J18H/10 + L6625-KP	5.59	5.63	29.29	-	66.02	51	-	224	0.9	-	2.0
J18H/11 + L6625-KP	5.59	5.63	31.06	-	67.80	56	-	228	0.9	-	2.0
J18H/12 + L6625-KP	5.59	5.63	32.83	-	69.57	61	-	233	0.9	-	2.0
J18H/13 + L6630-KP	5.59	5.63	34.61	-	73.70	65	-	250	0.9	-	2.0
J18H/14 + L6630-KP	5.59	5.63	36.38	-	75.47	69	-	255	1.5	-	2.5
J18H/15 + L6635-KP	5.59	5.63	38.15	-	79.61	76	-	305	1.5	-	5.8
J18H/16 + L6635-KP	5.59	5.63	39.92	-	81.38	80	-	309	1.5	-	5.8
J18H/17 + L6635-KP	5.59	5.63	41.69	-	83.15	84	-	314	1.5	-	5.8
J18H/18 + L6640-KP	5.59	5.63	43.46	-	88.07	89	-	336	1.5	-	6.2
J18H/19 + L6640-KP	5.59	5.63	45.24	-	89.84	93	-	340	1.5	-	6.2
J18H/20 + L6650-KP	5.59	5.63	47.01	-	93.58	100	-	373	1.5	-	6.2
J18H/21 + L6650-KP	5.59	5.63	48.78	-	95.35	104	-	377	1.5	-	6.2
J18H/22 + L6650-KP	5.59	5.63	50.55	-	97.13	110	-	383	1.5	-	6.2
J18H/23 + L6650-KP	5.59	5.63	52.32	-	98.90	115	-	388	1.5	-	6.2
J18H/24 + L6650-KP	5.59	5.63	54.09	-	100.67	119	-	393	1.5	-	6.2
J18H/25 + L8660-KH	7.48	7.48	58.98	-	106.69	124	-	596	1.5	-	9.0
J18H/26 + L8660-KH	7.48	7.48	60.75	-	108.46	129	-	601	1.5	-	9.0
J18H/27 + L8660-KH	7.48	7.48	62.52	-	110.24	134	-	606	1.5	-	9.0
J18H/28 + L8660-KH	7.48	7.48	64.29	-	112.01	138	-	610	1.5	-	9.0
J18H/29 + L8660-KH	7.48	7.48	66.06	-	113.78	143	-	615	1.5	-	9.0
J18H/30 + L8675-KH	7.48	7.48	67.83	-	117.52	149	-	651	1.5	-	9.2

Note: ØE = For single cable motor maximum diameter of pump inclusive of cable guard.

For two cable motor maximum diameter of pump inclusive of cable guard will increase by 0.12 inch.

Rp 2 & Rp 3 are available on request.

Add -T subscript to motor type for 4" Oil filled and Water filled 3 ~ motor.

All dimensions in inches unless otherwise noted.

Performance curves

Radial flow 6" stainless steel submersible bore well pumps

J18H

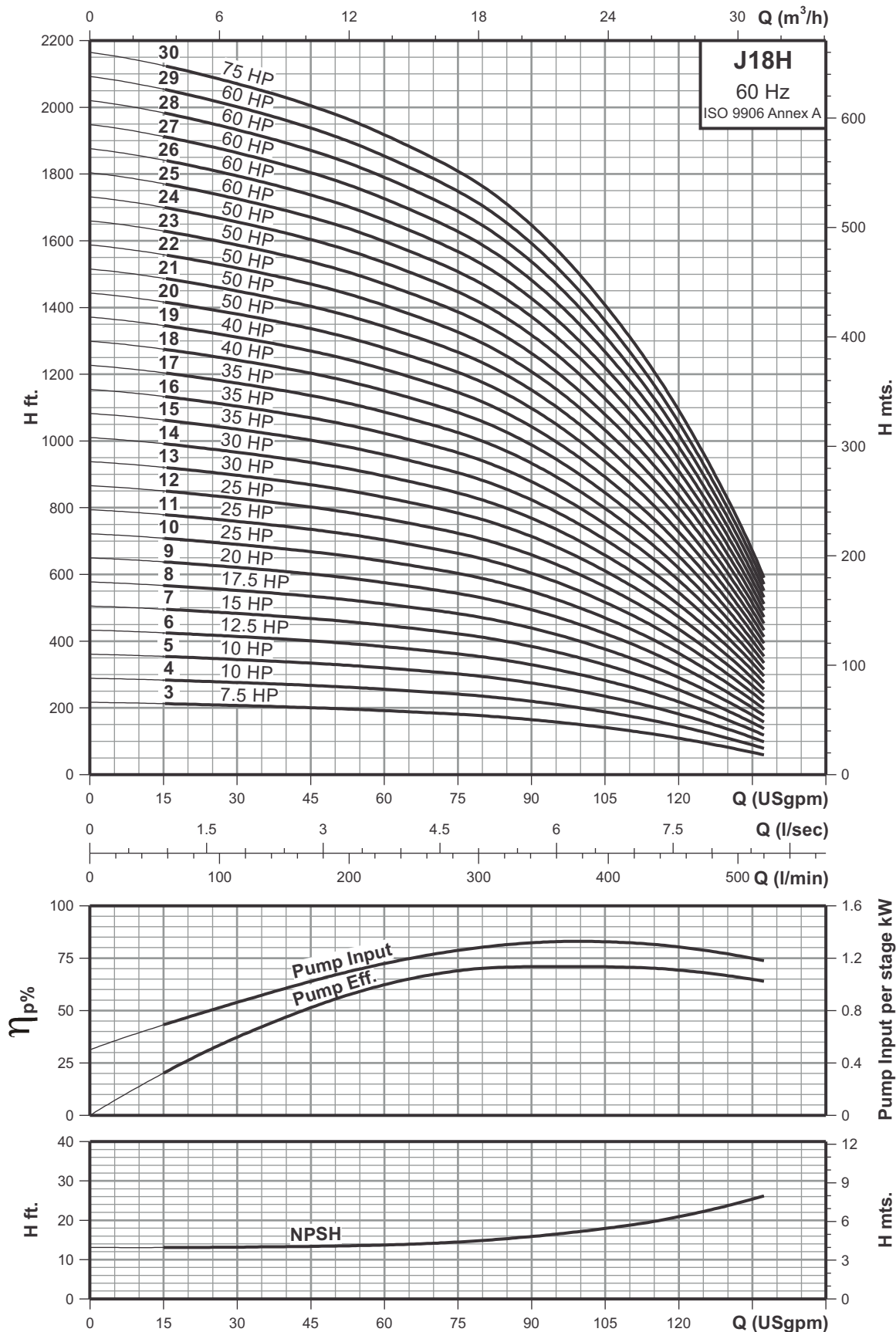

Technical data

Mixed flow 6" stainless steel submersible bore well pumps

W17

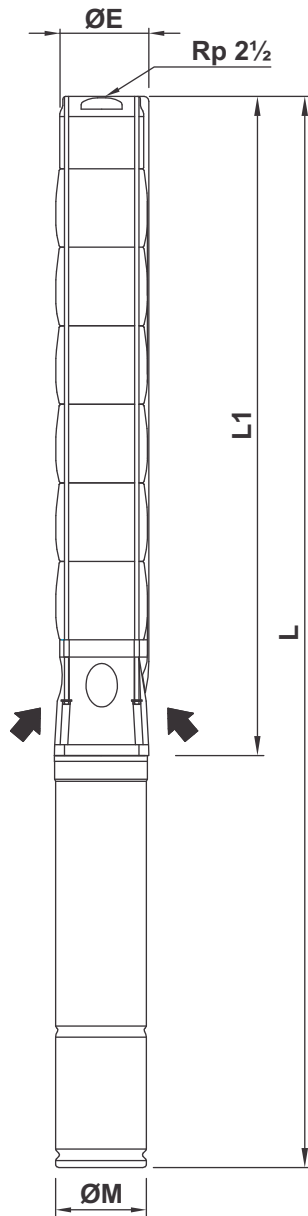

Performance chart

Pump type	Motor type		HP	kW	Q l/min USgpm	n = 3450 rpm						
	Oil filled	Water filled				0	38	68	151	227	303	447
						0	10	18	40	60	80	118
W17/1	H4615	L4615	1.50	1.10	H ft.	55	57	57	53	47	37	20
W17/2	H4630	L4630	3.00	2.20		107	109	109	104	97	83	40
W17/3	H4655	L4655	5.50	4.00		159	160	163	156	145	128	68
W17/4	H4655	L4655	5.50	4.00		211	212	217	207	191	167	96
W17/5	H4675	L4675	7.50	5.50		263	263	270	260	240	211	120
W17/6	H4675	L4675	7.50	5.50		315	315	321	310	287	250	139
W17/7	H46100	L6610-KP	10.0	7.50		367	366	374	361	335	295	166
W17/8	H46100	L6610-KP	10.0	7.50		419	418	428	412	381	333	188
W17/9	H46100	L6610-KP	10.0	7.50		471	469	475	460	428	375	208
W17/10	-	L6615-KP	15.0	11.0		523	521	530	513	479	420	238
W17/11	-	L6615-KP	15.0	11.0		575	572	582	562	524	460	258
W17/12	-	L6615-KP	15.0	11.0		627	624	636	615	574	506	287
W17/13	-	L6615-KP	15.0	11.0		679	675	690	667	620	543	306
W17/14	-	L6620-KP	20.0	15.0		747	750	747	724	673	594	337
W17/15	-	L6620-KP	20.0	15.0		796	800	798	772	719	630	352
W17/16	-	L6620-KP	20.0	15.0		851	855	853	828	771	680	388
W17/17	-	L6620-KP	20.0	15.0		904	909	907	877	815	717	408

Dimensions & weights of pump with Oil filled motor

Type Pump + Motor	ØM [inch]	ØE [inch]	Length [inch]			Gross weight [lbs]			Gross volume [ft³]		
			L1	L		Pump	Pump+Motor		Pump	Pump+Motor	
				1 ~	3 ~		1 ~	3 ~		1 ~	3 ~
W17/1 + H4615	3.74	5.16	12.36	30.67	29.09	15	45	41	0.8	1.2	1.2
W17/2 + H4630	3.74	5.16	14.72	36.97	34.61	18	62	53	0.8	1.2	1.2
W17/3 + H4655	3.74	5.16	17.13	43.31	41.34	20	70	67	0.8	1.3	1.2
W17/4 + H4655	3.74	5.16	19.49	45.67	43.70	23	73	70	0.8	1.3	1.2
W17/5 + H4675	3.74	5.16	21.89	-	48.07	26	-	80	0.8	-	1.3
W17/6 + H4675	3.74	5.16	24.25	-	50.43	28	-	83	0.8	-	1.3
W17/7 + H46100	3.74	5.16	26.65	-	58.35	32	-	102	0.8	-	1.3
W17/8 + H46100	3.74	5.16	29.02	-	60.71	35	-	104	0.8	-	1.3
W17/9 + H46100	3.74	5.16	31.42	-	63.11	37	-	107	0.8	-	1.3

Dimensions & weights of pump with Water filled motor

Type Pump + Motor	ØM [inch]	ØE [inch]	Length [inch]			Gross weight [lbs]			Gross volume [ft³]		
			L1	L		Pump	Pump+Motor		Pump	Pump+Motor	
				1 ~	3 ~		1 ~	3 ~		1 ~	3 ~
W17/1 + L4615	3.74	5.16	12.36	32.48	32.87	15	57	60	0.8	1.2	1.2
W17/2 + L4630	3.74	5.16	14.72	42.72	41.14	18	76	74	0.8	1.3	1.3
W17/3 + L4655	3.74	5.16	17.13	50.24	49.45	20	87	94	0.8	1.3	1.3
W17/4 + L4655	3.74	5.16	19.49	52.60	51.81	23	90	97	0.8	1.3	1.3
W17/5 + L4675	3.74	5.16	21.89	-	56.97	26	-	101	0.8	-	1.3
W17/6 + L4675	3.74	5.16	24.25	-	59.33	28	-	104	0.8	-	1.3
W17/7 + L6610-KP	5.59	5.59	27.28	-	55.16	32	-	151	0.8	-	1.7
W17/8 + L6610-KP	5.59	5.59	29.65	-	57.52	35	-	154	0.8	-	1.7
W17/9 + L6610-KP	5.59	5.59	32.05	-	59.92	37	-	157	0.8	-	1.7
W17/10 + L6615-KP	5.59	5.59	34.41	-	65.83	40	-	181	0.8	-	1.9
W17/11 + L6615-KP	5.59	5.59	36.81	-	68.23	43	-	183	0.8	-	1.9
W17/12 + L6615-KP	5.59	5.59	39.17	-	70.59	47	-	187	1.3	-	2.4
W17/13 + L6615-KP	5.59	5.59	41.57	-	72.99	50	-	190	1.3	-	2.4
W17/14 + L6620-KP	5.59	5.59	43.94	-	77.91	52	-	207	1.3	-	2.4
W17/15 + L6620-KP	5.59	5.59	46.34	-	80.31	55	-	210	1.3	-	2.4
W17/16 + L6620-KP	5.59	5.59	48.70	-	82.68	58	-	213	1.3	-	2.4
W17/17 + L6620-KP	5.59	5.59	51.10	-	85.08	61	-	216	1.3	-	2.4

Note: ØE = For single cable motor maximum diameter of pump inclusive of cable guard.
For two cable motor maximum diameter of pump inclusive of cable guard will increase by 0.12 inch.

Add -T subscript to motor type for 4" Oil filled and Water filled 3 ~ motor.
All dimensions in inches unless otherwise noted.

Performance curves

Mixed flow 6" stainless steel submersible bore well pumps

W17

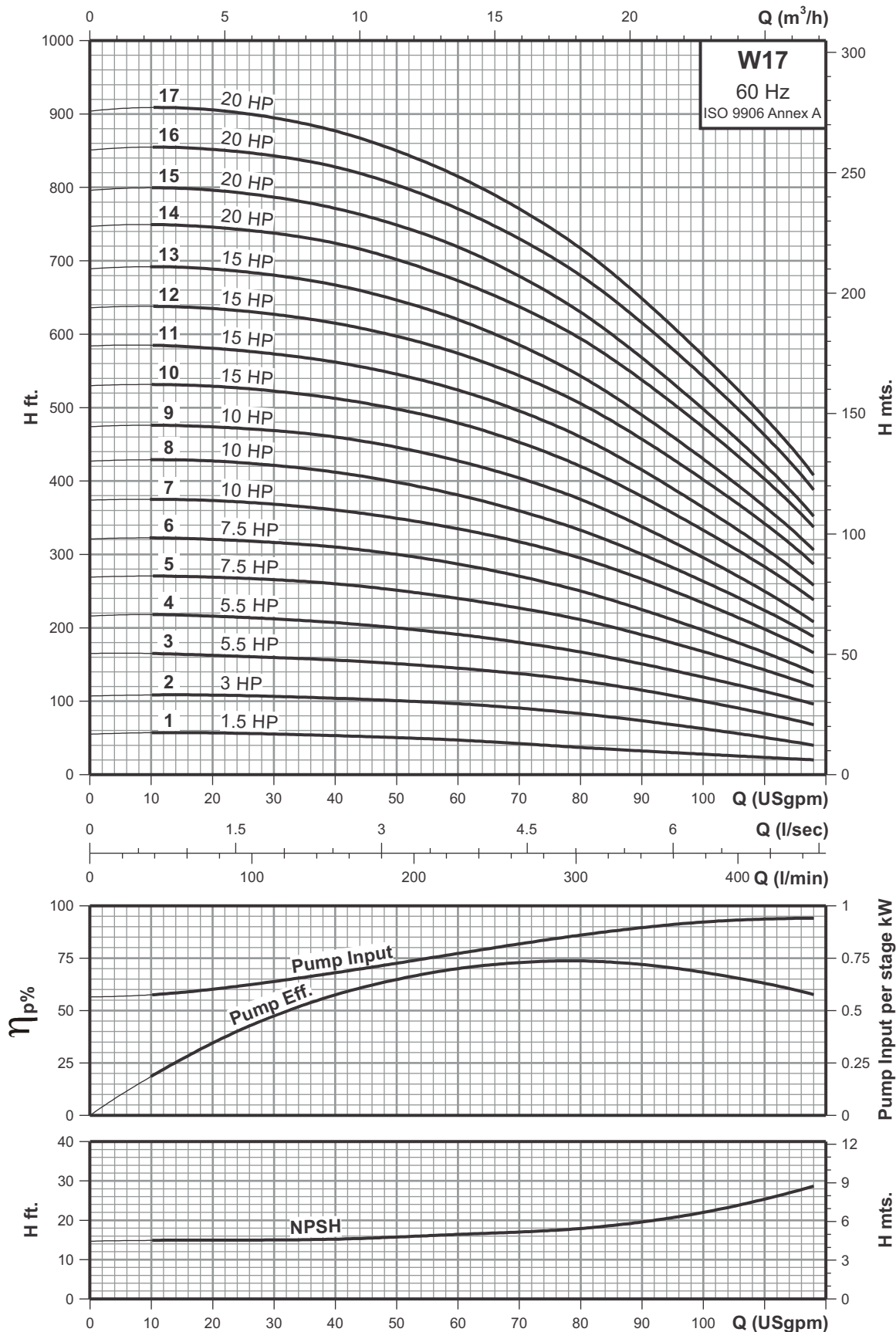

Technical data

Mixed flow 6" stainless steel submersible bore well pumps

W17

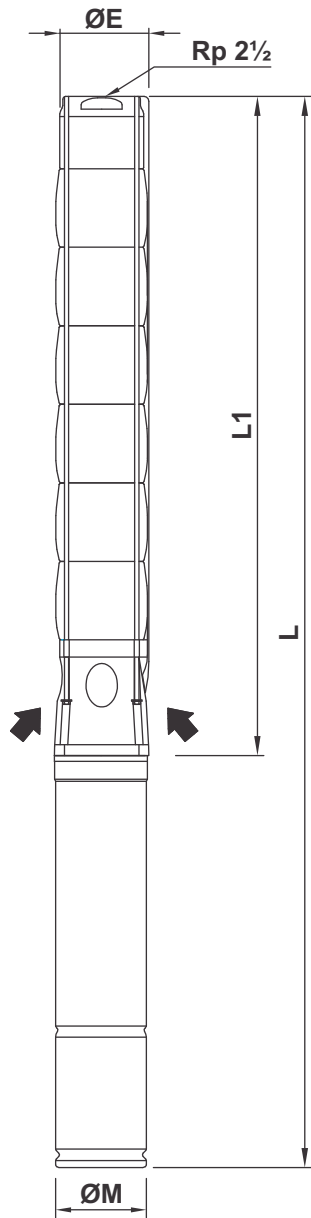

W17/33 to W17/39 are mounted in sleeve for Rp 3 connection.

Performance chart

Pump type	Motor type	HP	kW	Q	n = 3450 rpm						
					I/min	0	38	68	151	227	303
	Water filled	USgpm	0	10	18	40	60	80	118		
W17/18	L6620-KP	20.0	15.0	H ft.	956	960	958	925	860	756	429
W17/19	L6625-KP	25.0	18.5		1014	1020	1018	987	921	815	467
W17/20	L6625-KP	25.0	18.5		1066	1071	1069	1038	967	850	491
W17/21	L6625-KP	25.0	18.5		1119	1124	1122	1087	1010	887	509
W17/22	L6625-KP	25.0	18.5		1166	1171	1169	1133	1057	927	529
W17/23	L6630-KP	30.0	22.0		1225	1230	1228	1190	1110	980	561
W17/24	L6630-KP	30.0	22.0		1279	1283	1279	1240	1156	1020	581
W17/25	L6630-KP	30.0	22.0		1323	1329	1327	1286	1200	1057	600
W17/26	L6630-KP	30.0	22.0		1379	1383	1380	1340	1245	1095	620
W17/27	L6630-KP	30.0	22.0		1446	1450	1448	1407	1312	1160	677
W17/28	L6640-KP	40.0	30.0		1497	1501	1497	1455	1360	1200	698
W17/29	L6640-KP	40.0	30.0		1549	1554	1551	1507	1406	1240	720
W17/30	L6640-KP	40.0	30.0		1595	1602	1600	1551	1449	1280	739
W17/33	L6640-KP	40.0	30.0		1760	1767	1764	1709	1591	1400	803
W17/36	L6640-KP	40.0	30.0		1913	1919	1914	1852	1725	1519	858
W17/39	L6650-KP	50.0	37.0		2079	2085	2081	2024	1900	1682	981

Dimensions & weights of pump with Water filled motor

Type Pump + Motor	ØM [inch]	ØE [inch]	Length [inch]			Gross weight [lbs]			Gross volume [ft³]		
			L1	L		Pump	Pump+Motor		Pump	Pump+Motor	
				1 ~	3 ~		1 ~	3 ~		1 ~	3 ~
W17/18 + L6620-KP	5.59	5.59	53.46	-	87.44	63	-	218	1.3	-	2.4
W17/19 + L6625-KP	5.59	5.59	55.87	-	92.60	66	-	239	1.3	-	2.4
W17/20 + L6625-KP	5.59	5.59	58.86	-	95.59	69	-	241	1.3	-	2.4
W17/21 + L6625-KP	5.59	5.59	61.26	-	97.99	72	-	245	1.6	-	2.7
W17/22 + L6625-KP	5.59	5.59	63.62	-	100.35	75	-	248	1.6	-	2.7
W17/23 + L6630-KP	5.59	5.59	65.98	-	105.08	78	-	264	1.6	-	2.7
W17/24 + L6630-KP	5.59	5.59	68.39	-	107.48	81	-	267	1.6	-	2.7
W17/25 + L6630-KP	5.59	5.59	70.79	-	109.88	83	-	269	1.6	-	2.7
W17/26 + L6630-KP	5.59	5.59	73.15	-	112.24	86	-	272	1.6	-	2.7
W17/27 + L6630-KP	5.59	5.59	75.55	-	114.65	89	-	275	1.6	-	2.7
W17/28 + L6640-KP	5.59	5.59	77.91	-	122.52	97	-	344	1.6	-	6.3
W17/29 + L6640-KP	5.59	5.59	80.31	-	124.92	101	-	348	1.7	-	6.4
W17/30 + L6640-KP	5.59	5.59	82.68	-	127.28	105	-	352	1.7	-	6.4
W17/33 + L6640-KP	5.59	6.89	98.94	-	143.54	116	-	363	1.9	-	6.6
W17/36 + L6640-KP	5.59	6.89	106.06	-	150.67	128	-	375	2.0	-	6.7
W17/39 + L6650-KP	5.59	6.89	113.23	-	159.80	140	-	413	2.2	-	6.9

Note: ØE = For single cable motor maximum diameter of pump inclusive of cable guard.
 For two cable motor maximum diameter of pump inclusive of cable guard will increase by 0.12 inch.
 All dimensions in inches unless otherwise noted.

Performance curves

Mixed flow 6" stainless steel submersible bore well pumps

W17

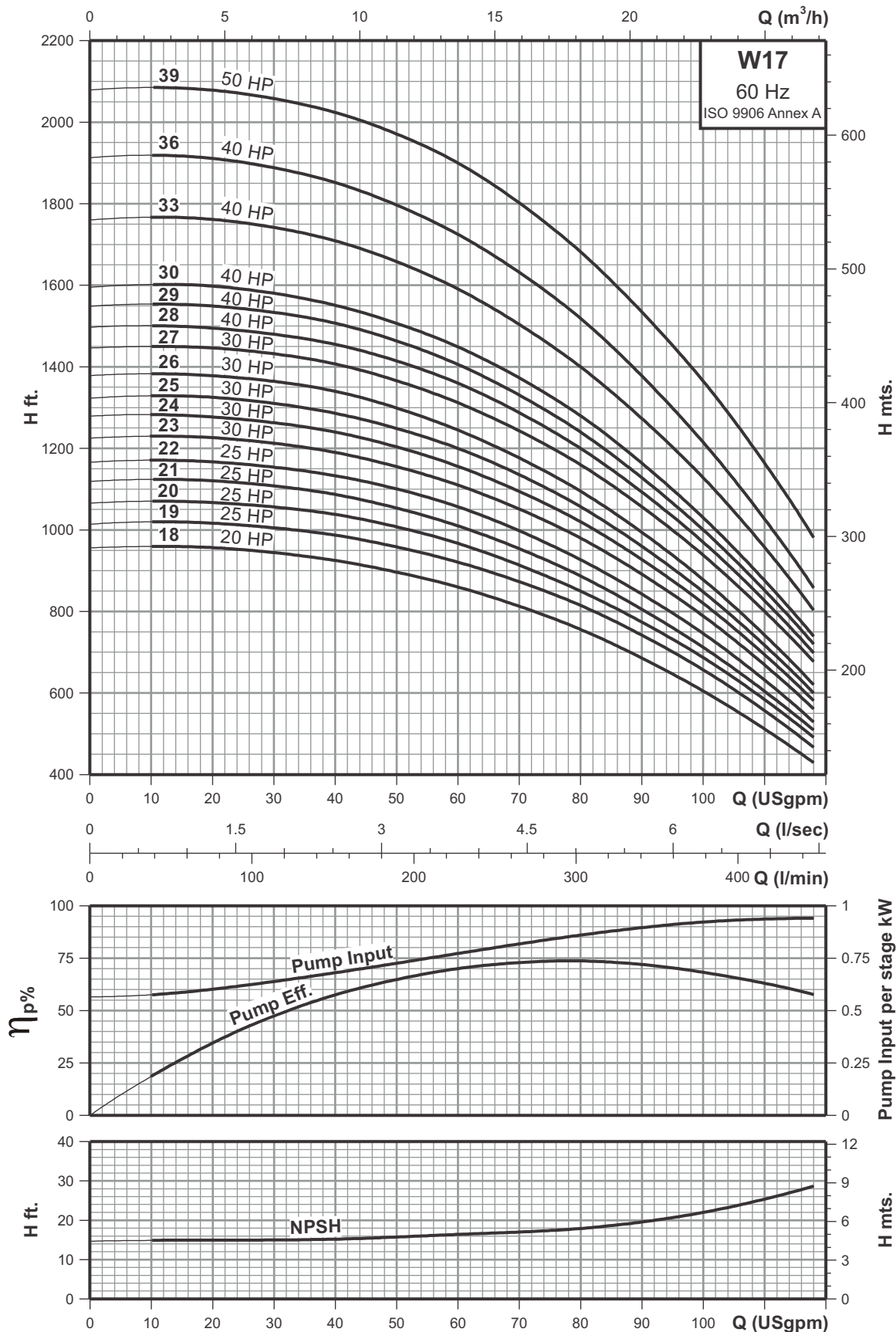

Technical data

Mixed flow 6" stainless steel submersible bore well pumps

W30

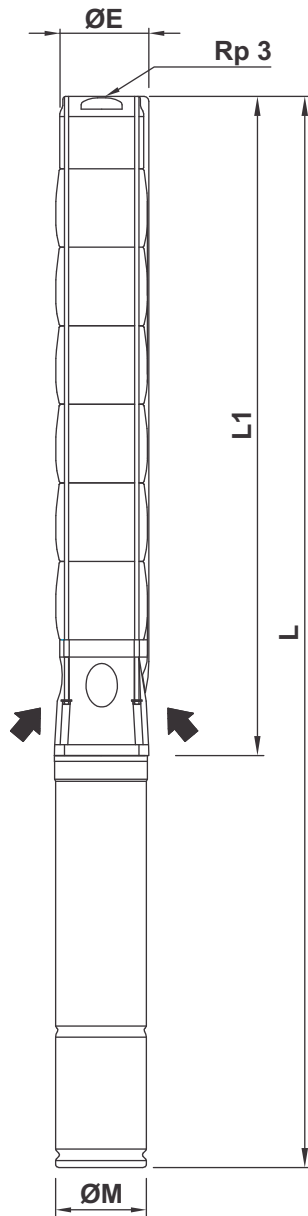

Performance chart

Pump type	Motor type		HP	kW	Q l/min USgpm	n = 3450 rpm						
	Oil filled	Water filled				0	67	200	400	533	667	783
						0	17.6	52.8	105.7	140.9	176.2	207
W30/1	H4620	L4620	2.00	1.50	H ft.	55	55	52	43	36	26	16
W30/2	H4640	L4640	4.00	3.00		110	110	104	89	75	59	34
W30/3	H4655	L4655	5.50	4.00		164	164	154	131	115	89	56
W30/4	H4675	L4675	7.50	5.50		218	219	207	179	157	121	79
W30/5	H46100	L6610-KP	10.0	7.50		272	274	259	223	197	154	100
W30/6	-	L6612-KP	12.5	9.30		329	328	311	271	240	187	125
W30/7	-	L6612-KP	12.5	9.30		377	379	361	312	276	213	141
W30/8	-	L6615-KP	15.0	11.0		435	436	413	361	318	246	164
W30/9	-	L6617-KP	17.5	13.0		489	492	467	408	361	282	189
W30/10	-	L6617-KP	17.5	13.0		541	545	515	449	397	310	205
W30/11	-	L6620-KP	20.0	15.0		597	602	571	499	440	344	230
W30/12	-	L6625-KP	25.0	18.5		655	659	628	550	486	384	261
W30/13	-	L6625-KP	25.0	18.5		709	714	677	594	525	417	277
W30/14	-	L6625-KP	25.0	18.5		761	764	725	635	564	453	295
W30/15	-	L6630-KP	30.0	22.0		817	822	781	682	604	476	318
W30/16	-	L6630-KP	30.0	22.0		868	874	830	725	640	501	336
W30/17	-	L6630-KP	30.0	22.0		919	927	879	766	679	528	354

Dimensions & weights of pump with Oil filled motor

Type Pump + Motor	ØM [inch]	ØE [inch]	Length [inch]			Gross weight [lbs]			Gross volume [ft³]		
			L1	L		Pump	Pump+Motor		Pump	Pump+Motor	
				1 ~	3 ~		1 ~	3 ~		1 ~	3 ~
W30/1 + H4620	3.74	5.16	13.74	33.62	32.05	15	50	48	0.8	1.2	1.2
W30/2 + H4640	3.74	5.16	17.52	-	39.76	19	-	62	0.8	-	1.2
W30/3 + H4655	3.74	5.16	21.30	47.48	45.51	24	73	71	0.8	1.3	1.2
W30/4 + H4675	3.74	5.16	25.08	-	51.26	28	-	83	0.8	-	1.3
W30/5 + H46100	3.74	5.16	28.86	-	60.55	33	-	103	0.8	-	1.3

Dimensions & weights of pump with Water filled motor

Type Pump + Motor	ØM [inch]	ØE [inch]	Length [inch]			Gross weight [lbs]			Gross volume [ft³]		
			L1	L		Pump	Pump+Motor		Pump	Pump+Motor	
				1 ~	3 ~		1 ~	3 ~		1 ~	3 ~
W30/1 + L4620	3.74	5.16	13.74	37.80	36.22	15	65	65	0.8	1.2	1.2
W30/2 + L4640	3.74	5.16	17.52	-	45.91	19	-	81	0.8	-	1.3
W30/3 + L4655	3.74	5.16	21.30	54.41	53.62	24	90	97	0.8	1.3	1.3
W30/4 + L4675	3.74	5.16	25.08	-	60.16	28	-	104	0.8	-	1.3
W30/5 + L6610-KP	5.59	5.59	29.49	-	57.36	33	-	152	0.8	-	1.7
W30/6 + L6612-KP	5.59	5.59	33.27	-	63.11	37	-	168	0.8	-	1.7
W30/7 + L6612-KP	5.59	5.59	37.05	-	66.89	42	-	173	0.8	-	1.7
W30/8 + L6615-KP	5.59	5.59	40.83	-	72.24	48	-	188	1.3	-	2.4
W30/9 + L6617-KP	5.59	5.59	44.61	-	77.40	52	-	202	1.3	-	2.4
W30/10 + L6617-KP	5.59	5.59	48.39	-	81.18	57	-	207	1.3	-	2.4
W30/11 + L6620-KP	5.59	5.59	52.17	-	86.14	62	-	217	1.3	-	2.4
W30/12 + L6625-KP	5.59	5.59	55.94	-	92.68	66	-	239	1.3	-	2.4
W30/13 + L6625-KP	5.59	5.59	59.72	-	96.46	72	-	244	1.6	-	2.7
W30/14 + L6625-KP	5.59	5.59	63.50	-	100.24	76	-	249	1.6	-	2.7
W30/15 + L6630-KP	5.59	5.59	67.28	-	106.38	81	-	267	1.6	-	2.7
W30/16 + L6630-KP	5.59	5.59	71.06	-	110.16	86	-	271	1.6	-	2.7
W30/17 + L6630-KP	5.59	5.59	74.84	-	113.94	90	-	276	1.6	-	2.7

Note: ØE = For single cable motor maximum diameter of pump inclusive of cable guard.
For two cable motor maximum diameter of pump inclusive of cable guard will increase by 0.12 inch.

Add -T subscript to motor type for 4" Oil filled and Water filled 3 ~ motor.
All dimensions in inches unless otherwise noted.

Performance curves

Mixed flow 6" stainless steel submersible bore well pumps

W30

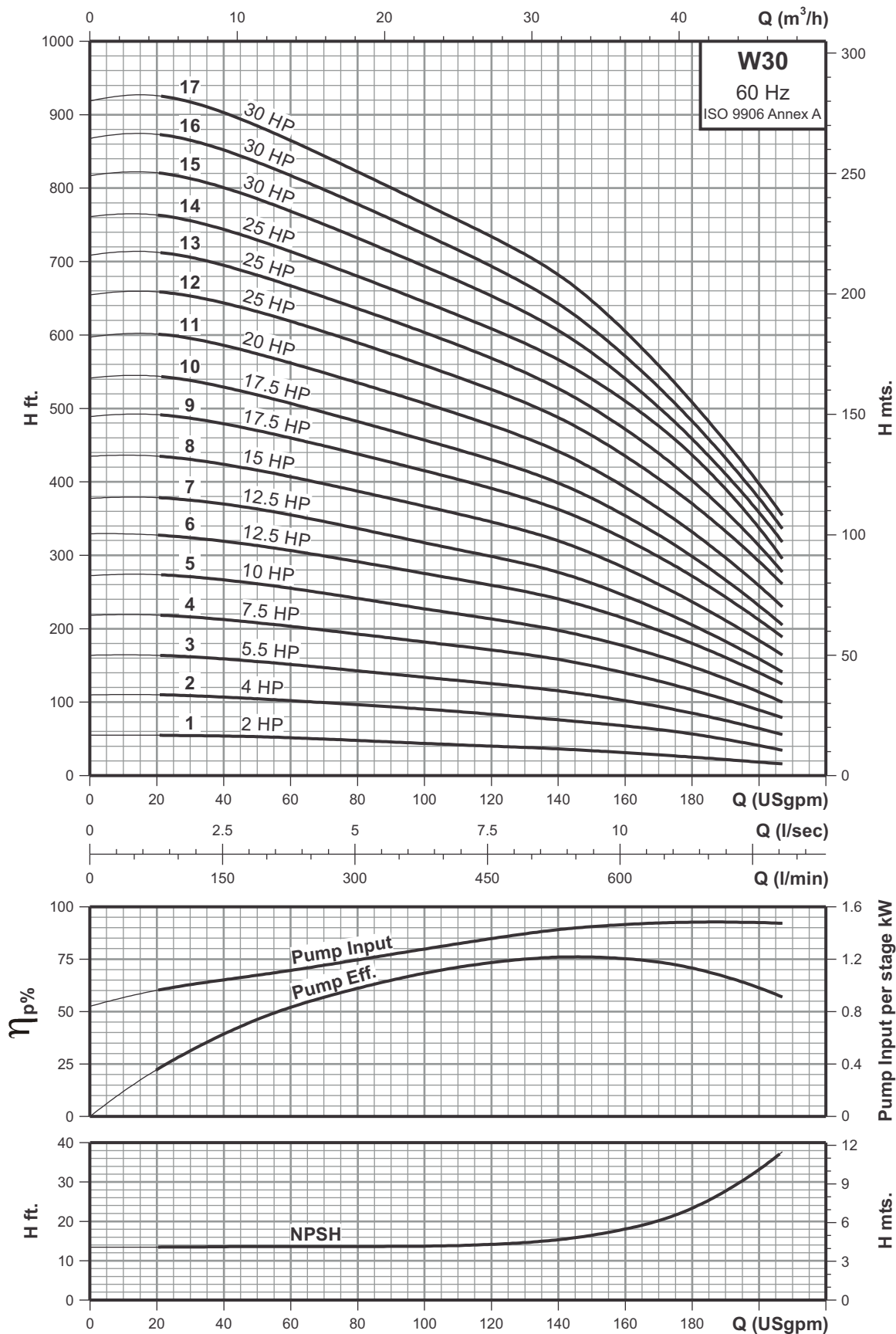

Technical data

Mixed flow 6" stainless steel submersible bore well pumps

W30

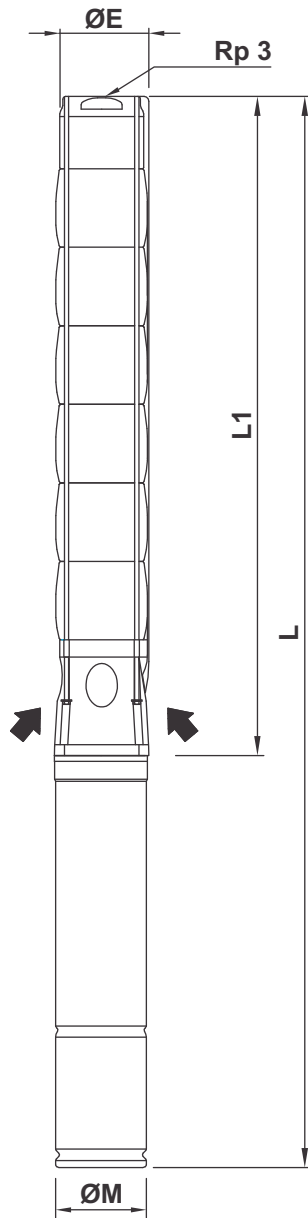

Performance chart

Pump type	Motor type	HP	kW	Q l/min	n = 3450 rpm						
					H ft.						
	Water filled	0	67	200	400	533	667	783			
				USgpm	0	17.6	52.8	105.7	140.9	176.2	207
W30/18	L6635-KP	35.0	26.0	H ft.	983	988	942	827	735	581	394
W30/19	L6635-KP	35.0	26.0		1037	1042	989	873	771	607	412
W30/20	L6635-KP	35.0	26.0		1089	1093	1038	912	810	636	431
W30/21	L6640-KP	40.0	30.0		1145	1148	1094	955	848	668	451
W30/22	L6640-KP	40.0	30.0		1198	1201	1145	997	886	694	471
W30/23	L6640-KP	40.0	30.0		1248	1253	1191	1040	919	722	489
W30/24	L6650-KP	50.0	37.0		1306	1316	1250	1102	981	778	528
W30/25	L6650-KP	50.0	37.0		1358	1371	1299	1148	1017	804	548
W30/26	L6650-KP	50.0	37.0		1407	1417	1352	1188	1050	833	564
W30/27	L6650-KP	50.0	37.0		1460	1473	1401	1230	1093	863	584
W30/28	L6650-KP	50.0	37.0		1514	1526	1447	1273	1129	892	600
W30/29	L8660-KH	60.0	45.0		1591	1604	1526	1345	1201	961	663
W30/31	L8660-KH	60.0	45.0		1693	1706	1627	1434	1280	1017	699
W30/33	L8660-KH	60.0	45.0		1801	1811	1729	1526	1355	1083	745
W30/36	L8675-KH	75.0	55.0		1972	1993	1900	1677	1503	1198	830
W30/39	L8675-KH	75.0	55.0		2133	2156	2054	1811	1617	1296	892

Dimensions & weights of pump with Water filled motor

Type Pump + Motor	ØM [inch]	ØE [inch]	Length [inch]			Gross weight [lbs]			Gross volume [ft³]		
			L1	L		Pump	Pump+Motor		Pump	Pump+Motor	
				1 ~	3 ~		1 ~	3 ~		1 ~	3 ~
W30/18 + L6635-KP	5.59	5.59	78.62	-	120.08	138	-	367	5.2	-	9.5
W30/19 + L6635-KP	5.59	5.59	82.40	-	123.86	144	-	374	5.4	-	9.7
W30/20 + L6635-KP	5.59	5.59	86.18	-	127.64	151	-	381	5.6	-	10.0
W30/21 + L6640-KP	5.59	5.59	89.96	-	134.57	158	-	405	5.9	-	10.6
W30/22 + L6640-KP	5.59	5.59	93.74	-	138.35	163	-	410	6.1	-	10.8
W30/23 + L6640-KP	5.59	5.59	97.52	-	142.13	77	-	324	6.3	-	11.0
W30/24 + L6650-KP	5.59	6.89	101.30	-	147.87	174	-	447	6.6	-	11.3
W30/25 + L6650-KP	5.59	6.89	105.08	-	151.65	181	-	454	6.8	-	11.5
W30/26 + L6650-KP	5.59	6.89	108.86	-	155.43	188	-	461	7.1	-	11.8
W30/27 + L6650-KP	5.59	6.89	112.64	-	159.21	194	-	468	7.3	-	12.0
W30/28 + L6650-KP	5.59	6.89	116.42	-	162.99	201	-	475	7.5	-	12.2
W30/29 + L8660-KH	7.48	7.48	127.91	-	175.63	208	-	680	7.8	-	15.3
W30/31 + L8660-KH	7.48	7.48	135.47	-	183.19	222	-	694	8.2	-	15.8
W30/33 + L8660-KH	7.48	7.48	143.03	-	190.75	235	-	707	8.7	-	16.2
W30/36 + L8675-KH	7.48	7.48	154.37	-	204.06	254	-	757	9.4	-	17.2
W30/39 + L8675-KH	7.48	7.48	165.71	-	215.39	274	-	777	10.1	-	17.9

W30/24 to W30/39 are mounted in sleeve for Rp 3 connection.

Note: ØE = For single cable motor maximum diameter of pump inclusive of cable guard.
For two cable motor maximum diameter of pump inclusive of cable guard will increase by 0.12 inch.
All dimensions in inches unless otherwise noted.

Performance curves

Mixed flow 6" stainless steel submersible bore well pumps

W30

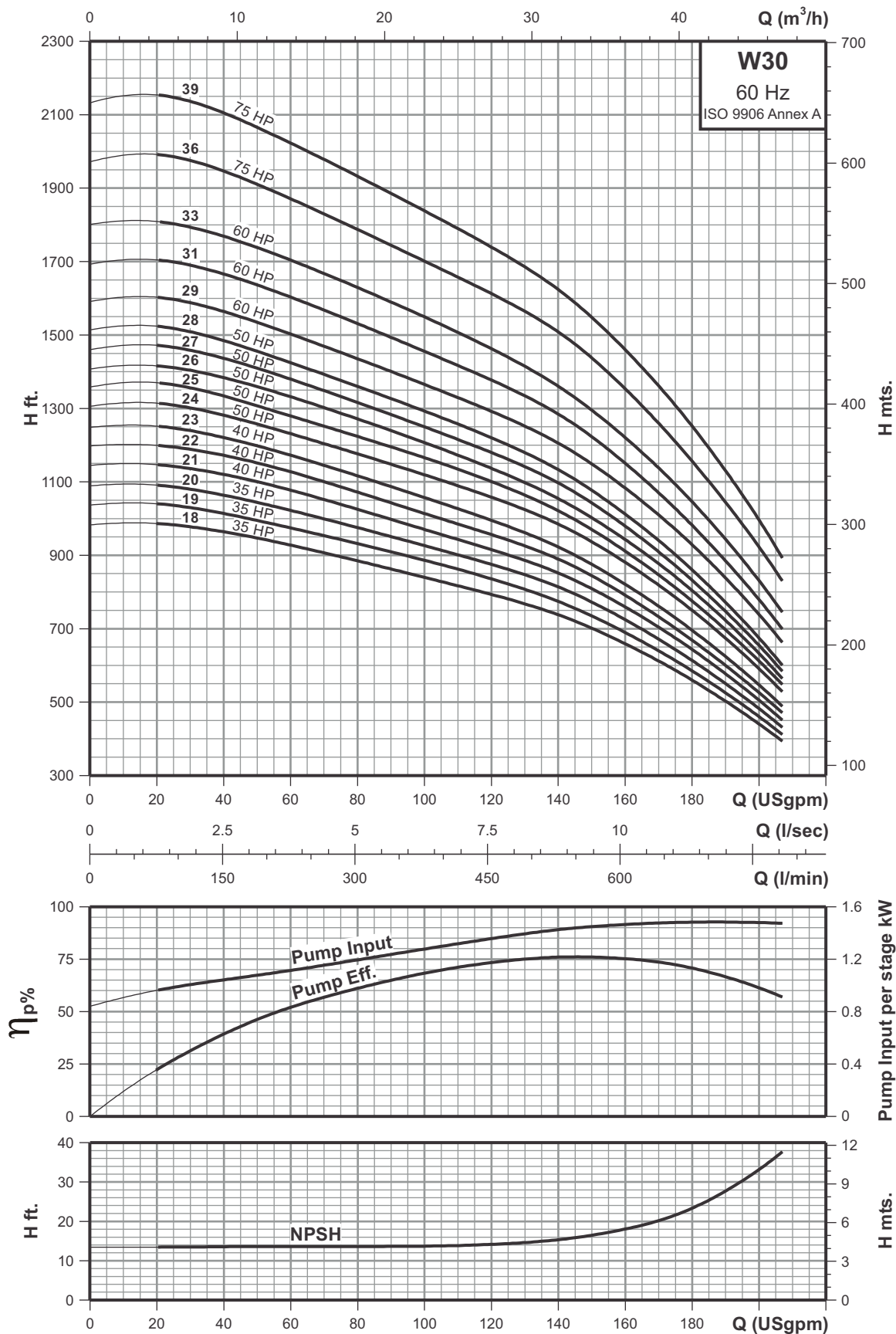

Technical data

Mixed flow 6" stainless steel submersible bore well pumps

W46

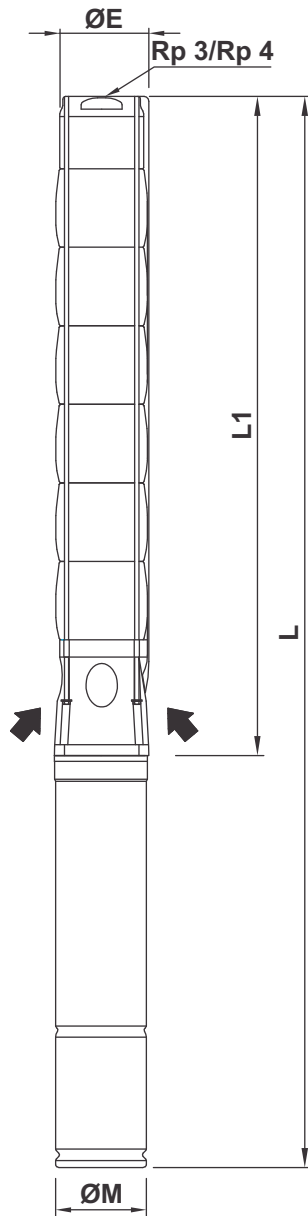

Performance chart

Pump type	Motor type		HP	kW	Q l/min USgpm	n = 3450 rpm					
	Oil filled	Water filled				0	167	500	667	933	1198
						0	44	132.1	176.2	246.5	316.5
W46/1-B	H4620	L4620	2.00	1.50	H ft.	49	44	37	33	20	1
W46/1-A	H4630	L4630	3.00	2.20		62	57	46	39	27	9
W46/1	H4640	L4640	4.00	3.00		65	62	52	47	35	18
W46/2-AB	H4655	L4655	5.50	4.00		104	98	85	75	52	16
W46/2	H4675	L4675	7.50	5.50		129	124	108	98	78	46
W46/3-BB	H4675	L4675	7.50	5.50		147	144	129	115	82	33
W46/3	H46100	L6610-KP	10.0	7.50		192	184	162	148	117	69
W46/4-BC	-	L6610-KP	10.0	7.50		212	205	180	162	120	56
W46/4	-	L6612-KP	12.5	9.30		256	247	217	197	156	94
W46/5-C	-	L6615-KP	15.0	11.0		299	289	253	230	178	101
W46/5	-	L6617-KP	17.5	13.0		322	312	275	249	200	125
W46/6-A	-	L6617-KP	17.5	13.0		375	363	320	292	230	137
W46/6	-	L6620-KP	20.0	15.0		387	373	329	301	241	150
W46/7-C	-	L6620-KP	20.0	15.0		427	412	363	331	260	151
W46/7	-	L6625-KP	25.0	18.5	453	436	387	354	285	179	

Dimensions & weights of pump with Oil filled motor

Type Pump + Motor	$\varnothing M$ [inch]	$\varnothing E$ [inch]	Length [inch]			Gross weight [lbs]			Gross volume [ft ³]		
			L1	L		Pump	Pump+Motor		Pump	Pump+Motor	
				1 ~	3 ~		1 ~	3 ~		1 ~	3 ~
W46/1-B + H4620	3.74	5.75	14.45	34.33	32.76	17	51	49	0.8	1.2	1.2
W46/1-A + H4630	3.74	5.75	14.45	36.69	34.33	17	61	52	0.8	1.2	1.2
W46/1 + H4640	3.74	5.75	14.45	-	36.69	17	-	59	0.8	-	1.2
W46/2-AB + H4655	3.74	5.75	18.90	45.08	43.11	22	72	70	0.8	1.3	1.2
W46/2 + H4675	3.74	5.75	18.90	-	45.08	22	-	77	0.8	-	1.3
W46/3-BB + H4675	3.74	5.75	23.35	-	49.53	28	-	83	0.8	-	1.3
W46/3 + H46100	3.74	5.75	23.35	-	55.04	28	-	98	0.8	-	1.3
W46/4-BC + H46100	3.74	5.75	27.80	-	59.49	35	-	104	0.8	-	1.3

Dimensions & weights of pump with Water filled motor

Type Pump + Motor	$\varnothing M$ [inch]	$\varnothing E$ [inch]	Length [inch]			Gross weight [lbs]			Gross volume [ft ³]		
			L1	L		Pump	Pump+Motor		Pump	Pump+Motor	
				1 ~	3 ~		1 ~	3 ~		1 ~	3 ~
W46/1-B + L4620	3.74	5.75	14.45	38.50	36.93	17	67	66	0.8	1.2	1.2
W46/1-A + L4630	3.74	5.75	14.45	42.44	40.87	17	75	73	0.8	1.3	1.3
W46/1 + L4640	3.74	5.75	14.45	-	42.83	17	-	78	0.8	-	1.3
W46/2-AB + L4655	3.74	5.75	18.90	52.01	51.22	22	89	96	0.8	1.3	1.3
W46/2 + L4675	3.74	5.75	18.90	-	53.98	22	-	98	0.8	-	1.3
W46/3-BB + L4675	3.74	5.75	23.35	-	58.43	28	-	104	0.8	-	1.3
W46/3 + L6610-KP	5.59	5.83	23.98	-	51.85	28	-	147	0.8	-	1.7
W46/4-BC + L6610-KP	5.59	5.83	28.43	-	56.30	35	-	154	0.8	-	1.7
W46/4 + L6612-KP	5.59	5.83	28.43	-	58.27	35	-	166	0.8	-	1.7
W46/5-C + L6615-KP	5.59	5.83	32.87	-	64.29	40	-	181	0.8	-	1.9
W46/5 + L6617-KP	5.59	5.83	32.87	-	65.67	40	-	190	0.8	-	1.9
W46/6-A + L6617-KP	5.59	5.83	37.32	-	70.12	46	-	196	0.8	-	1.9
W46/6 + L6620-KP	5.59	5.83	37.32	-	71.30	46	-	201	0.8	-	1.9
W46/7-C + L6620-KP	5.59	5.83	41.77	-	75.75	53	-	208	1.3	-	2.4
W46/7 + L6625-KP	5.59	5.83	41.77	-	78.50	53	-	225	1.3	-	2.4

Note: $\varnothing E$ = For single cable motor maximum diameter of pump inclusive of cable guard.
For two cable motor maximum diameter of pump inclusive of cable guard will increase by 0.12 inch.

Add -T subscript to motor type for 4" Oil filled and Water filled 3 ~ motor.
All dimensions in inches unless otherwise noted.

Performance curves

Mixed flow 6" stainless steel submersible bore well pumps

W46

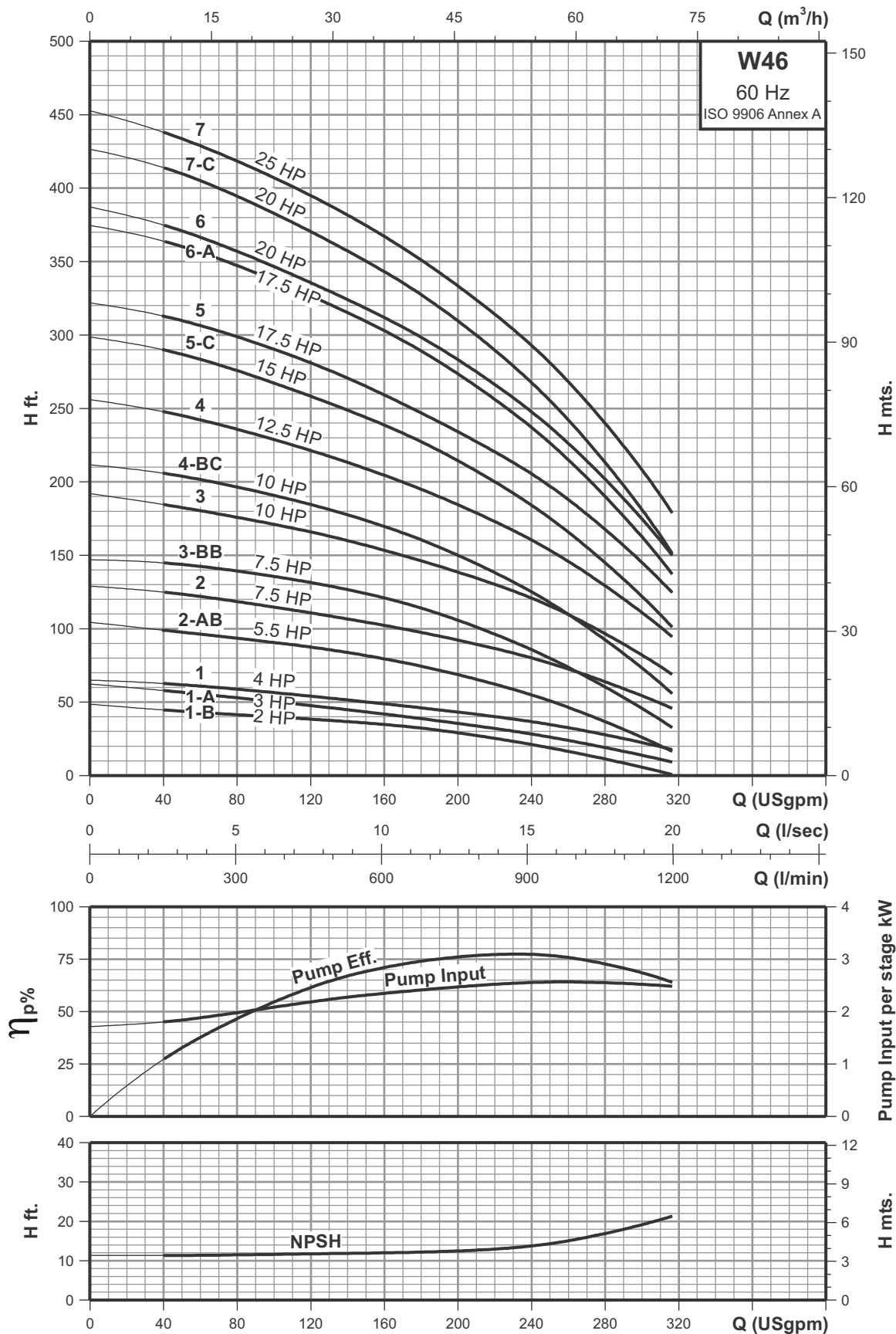

Technical data

Mixed flow 6" stainless steel submersible bore well pumps

W46

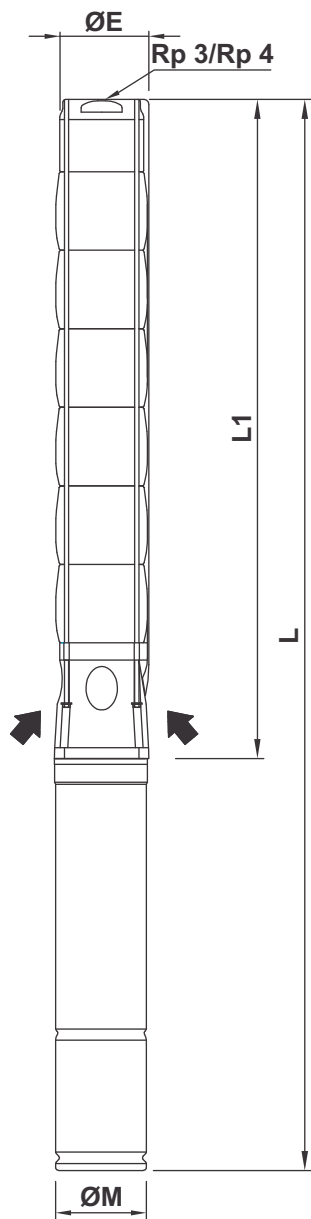

Performance chart

Pump type	Motor type	HP	kW	Q	n = 3450 rpm					
					l/min	0	167	500	667	933
	Water filled	USgpm	0	44	132.1	176.2	246.5	316.5		
W46/8	L6625-KP	25.0	18.5	H ft.	514	496	440	400	322	202
W46/9	L6630-KP	30.0	22.0		581	558	492	451	361	228
W46/10	L6630-KP	30.0	22.0		650	623	554	509	413	262
W46/11	L6635-KP	35.0	26.0		712	686	607	558	449	284
W46/12	L6640-KP	40.0	30.0		774	750	666	607	489	315
W46/13	L6640-KP	40.0	30.0		837	807	714	651	525	335
W46/14	L6650-KP	50.0	37.0		902	873	776	712	576	371
W46/15	L6650-KP	50.0	37.0		965	932	830	764	614	392
W46/16	L6650-KP	50.0	37.0		1027	994	883	810	651	415
W46/17	L6650-KP	50.0	37.0		1088	1050	935	856	691	440
W46/18	L8660-KH	60.0	45.0		1168	1130	1007	928	748	484
W46/19	L8660-KH	60.0	45.0		1230	1194	1061	974	789	509
W46/20	L8660-KH	60.0	45.0		1293	1253	1115	1027	830	528
W46/22	L8675-KH	75.0	55.0		1430	1385	1237	1138	919	590
W46/24	L8675-KH	75.0	55.0		1555	1509	1345	1240	1001	640

Dimensions & weights of pump with Water filled motor

Type Pump + Motor	ØM [inch]	ØE [inch]	Length [inch]		Gross weight [lbs]		Gross volume [ft³]				
			L1	L		Pump	Pump+Motor		Pump	Pump+Motor	
				1 ~	3 ~		1 ~	3 ~		1 ~	3 ~
W46/08 + L6625-KP	5.59	5.83	46.22	-	82.95	59	-	231	1.3	-	2.4
W46/09 + L6630-KP	5.59	5.83	50.67	-	89.76	64	-	250	1.3	-	2.4
W46/10 + L6630-KP	5.59	5.83	55.12	-	94.21	70	-	256	1.3	-	2.4
W46/11 + L6635-KP	5.59	5.83	59.57	-	101.02	76	-	305	1.3	-	5.6
W46/12 + L6640-KP	5.59	5.83	64.02	-	108.62	82	-	329	1.6	-	6.3
W46/13 + L6640-KP	5.59	5.83	68.46	-	113.07	88	-	335	1.6	-	6.3
W46/14 + L6650-KP	5.59	5.83	76.06	-	122.64	94	-	367	1.6	-	6.3
W46/15 + L6650-KP	5.59	5.83	80.51	-	127.09	142	-	416	5.2	-	9.9
W46/16 + L6650-KP	5.59	5.83	84.96	-	131.54	151	-	424	5.4	-	10.1
W46/17 + L6650-KP	5.59	5.83	89.41	-	135.98	158	-	431	5.7	-	10.4
W46/18 + L8660-KH	7.48	7.48	91.85	-	139.57	166	-	638	6.0	-	13.5
W46/19 + L8660-KH	7.48	7.48	96.30	-	144.02	174	-	646	6.3	-	13.8
W46/20 + L8660-KH	7.48	7.48	100.75	-	148.46	182	-	654	6.5	-	14.0
W46/22 + L8675-KH	7.48	7.48	116.06	-	165.75	198	-	700	7.1	-	14.9
W46/24 + L8675-KH	7.48	7.48	124.96	-	174.65	214	-	716	7.6	-	15.4

Note: ØE = For single cable motor maximum diameter of pump inclusive of cable guard.
For two cable motor maximum diameter of pump inclusive of cable guard will increase by 0.12 inch.

All dimensions in inches unless otherwise noted.

W46/20 to W46/24 are mounted in sleeve for Rp 3 connection.

Performance curves

Mixed flow 6" stainless steel submersible bore well pumps

W46

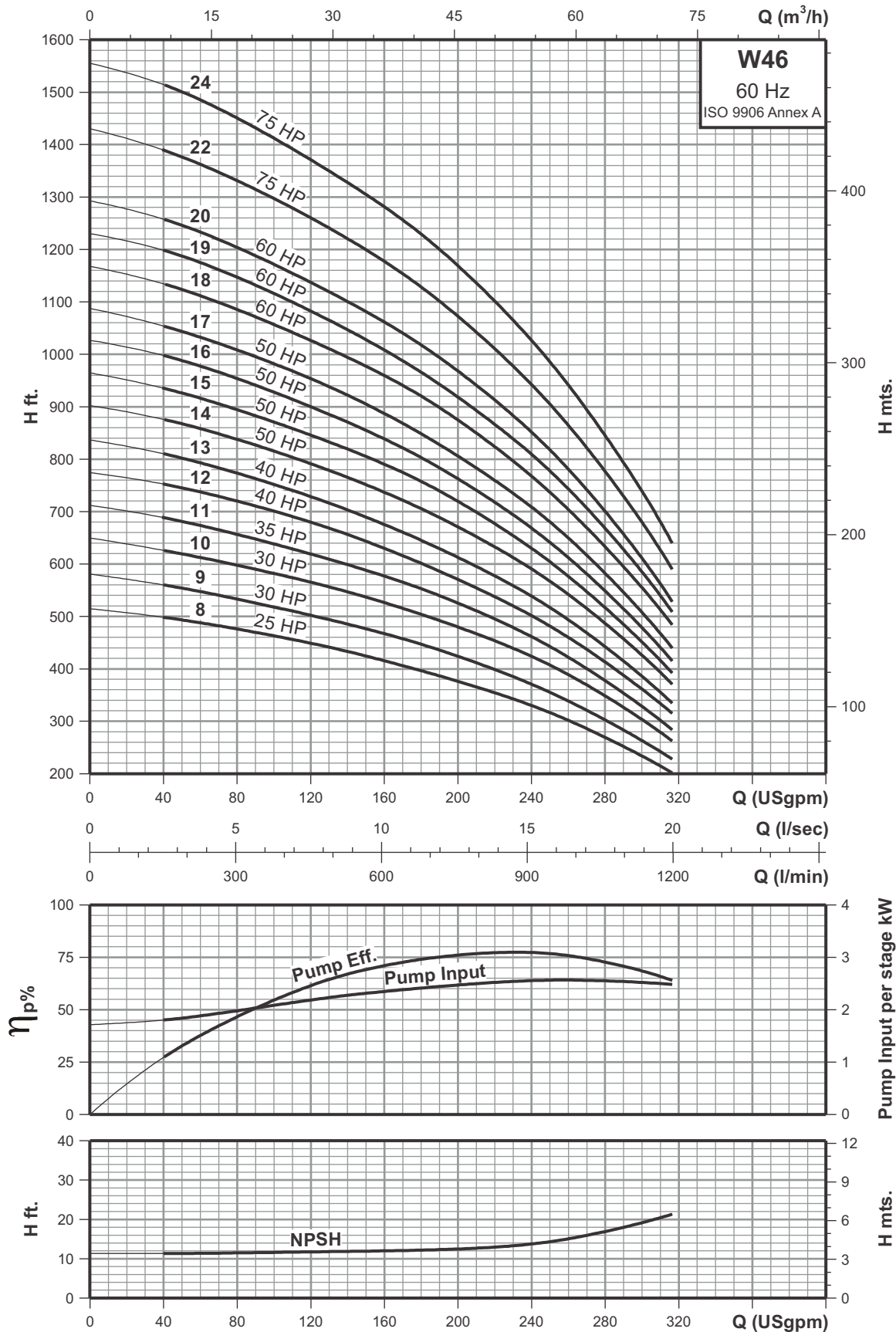

Technical data

Mixed flow 6" stainless steel submersible bore well pumps

W60

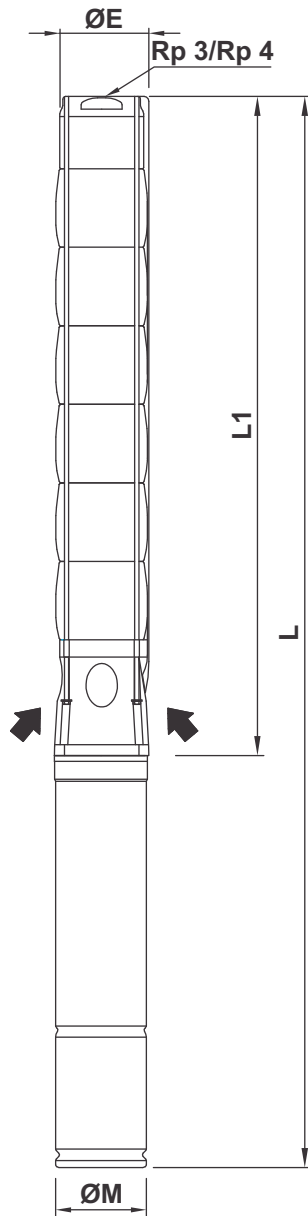

Performance chart

Pump type	Motor type		HP	kW	Q l/min USgpm	n = 3450 rpm						
	Oil filled	Water filled				0	83	167	500	834	1167	1550
						0	21.9	44	132.1	220.2	308.3	409.5
W60/1-B	H4630	L4630	3.00	2.20	H ft.	49	47	46	37	29	19	-
W60/1	H4655	L4655	5.50	4.00		63	62	62	57	41	32	8
W60/2-BB	H4655	L4655	5.50	4.00		90	89	87	75	62	42	0
W60/2	H4675	L4675	7.50	5.50		131	129	129	116	90	69	30
W60/3-A	H46100	L6610-KP	10.0	7.50		177	175	175	157	125	95	33
W60/3	-	L6612-KP	12.5	9.30		199	198	197	177	140	108	49
W60/4-AA	-	L6612-KP	12.5	9.30		225	222	222	200	160	120	35
W60/4	-	L6615-KP	15.0	11.0		266	263	262	236	186	146	69
W60/5	-	L6617-KP	17.5	13.0		335	331	329	297	237	184	90
W60/6-B	-	L6620-KP	20.0	15.0		385	382	380	344	281	217	103
W60/6	-	L6625-KP	25.0	18.5		408	405	403	364	292	230	118
W60/7	-	L6625-KP	25.0	18.5		473	468	466	420	341	266	138
W60/8	-	L6630-KP	30.0	22.0		541	535	531	481	387	302	154
W60/9-B	-	L6630-KP	30.0	22.0		581	574	571	515	417	322	154

Dimensions & weights of pump with Oil filled motor

Type Pump + Motor	ØM [inch]	ØE [inch]	Length [inch]			Gross weight [lbs]			Gross volume [ft³]		
			L1	L		Pump	Pump+Motor		Pump	Pump+Motor	
				1 ~	3 ~		1 ~	3 ~		1 ~	3 ~
W60/01-B + H4630	3.74	5.75	14.45	36.69	34.33	17	61	52	0.8	1.2	1.2
W60/01 + H4655	3.74	5.75	14.45	40.63	38.66	17	66	64	0.8	1.3	1.2
W60/02-BB + H4655	3.74	5.75	18.90	45.08	43.11	22	72	70	0.8	1.3	1.2
W60/02 + H4675	3.74	5.75	18.90	-	45.08	22	-	77	0.8	-	1.3
W60/03-A + H46100	3.74	5.75	23.35	-	55.04	28	-	98	0.8	-	1.3

Dimensions & weights of pump with Water filled motor

Type Pump + Motor	ØM [inch]	ØE [inch]	Length [inch]			Gross weight [lbs]			Gross volume [ft³]		
			L1	L		Pump	Pump+Motor		Pump	Pump+Motor	
				1 ~	3 ~		1 ~	3 ~		1 ~	3 ~
W60/01-B + L4630	3.74	5.75	14.45	42.44	40.87	17	75	73	0.8	1.3	1.3
W60/01 + L4655	3.74	5.75	14.45	47.56	46.77	17	84	90	0.8	1.3	1.3
W60/02-BB + L4655	3.74	5.75	18.90	52.01	51.22	22	89	96	0.8	1.3	1.3
W60/02 + L4675	3.74	5.75	18.90	-	53.98	22	-	98	0.8	-	1.3
W60/03-A + L6610-KP	5.59	5.83	23.98	-	51.85	28	-	147	0.8	-	1.7
W60/03 + L6612-KP	5.59	5.83	23.98	-	53.82	28	-	159	0.8	-	1.7
W60/04-AA + L6612-KP	5.59	5.83	28.43	-	58.27	35	-	166	0.8	-	1.7
W60/04 + L6615-KP	5.59	5.83	28.43	-	59.84	35	-	175	0.8	-	1.9
W60/05 + L6617-KP	5.59	5.83	32.87	-	65.67	40	-	190	0.8	-	1.9
W60/06-B + L6620-KP	5.59	5.83	37.32	-	71.30	46	-	201	0.8	-	1.9
W60/06 + L6625-KP	5.59	5.83	37.32	-	74.06	46	-	218	0.8	-	1.9
W60/07 + L6625-KP	5.59	5.83	41.77	-	78.50	53	-	225	1.3	-	2.4
W60/08 + L6630-KP	5.59	5.83	46.22	-	85.31	59	-	244	1.3	-	2.4
W60/09-B + L6630-KP	5.59	5.83	50.67	-	89.76	64	-	250	1.3	-	2.4

Note: ØE = For single cable motor maximum diameter of pump inclusive of cable guard.
For two cable motor maximum diameter of pump inclusive of cable guard will increase by 0.12 inch.

Add -T subscript to motor type for 4" Oil filled and Water filled 3 ~ motor.

All dimensions in inches unless otherwise noted.

Performance curves

Mixed flow 6" stainless steel submersible bore well pumps

W60

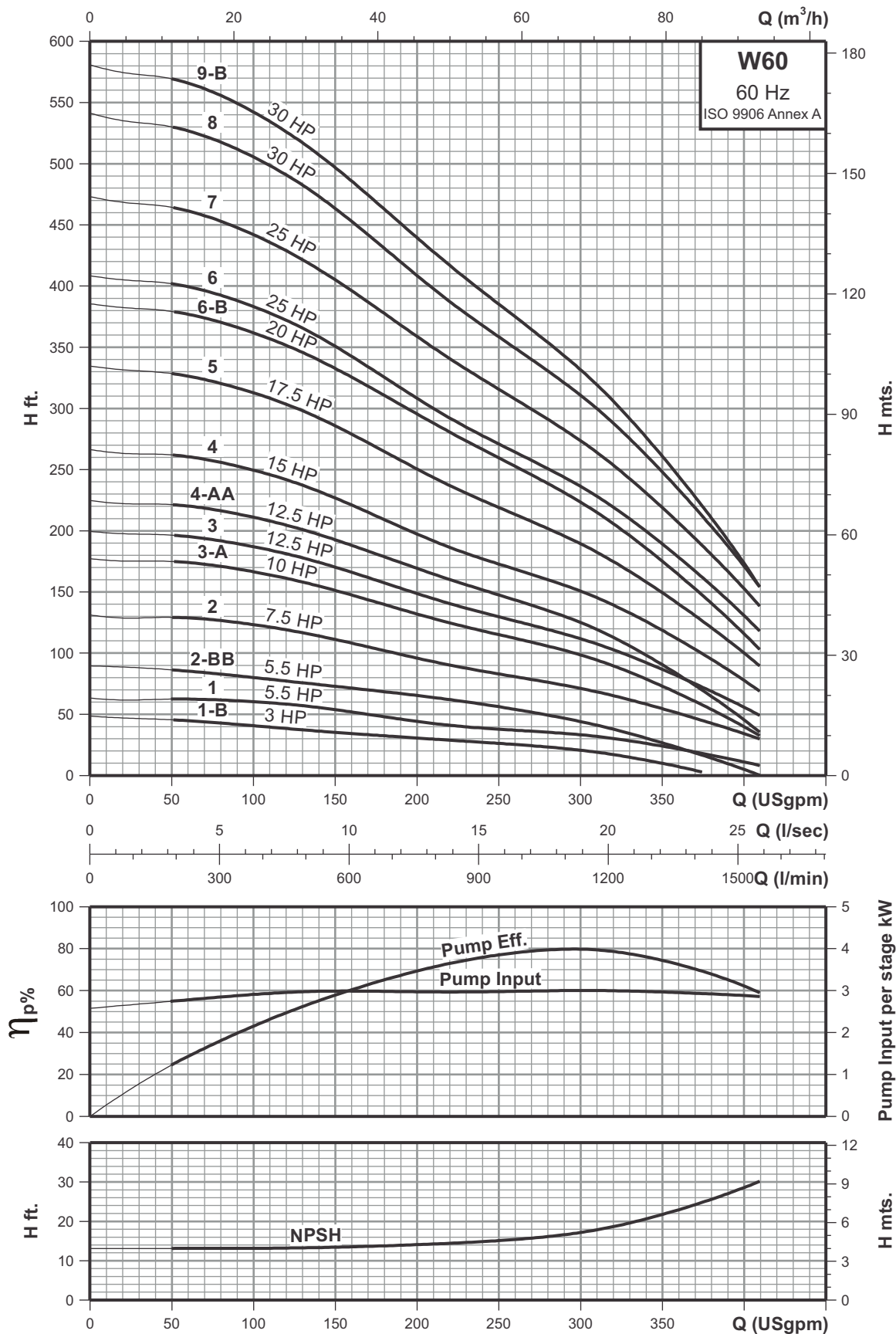

Technical data

Mixed flow 6" stainless steel submersible bore well pumps

W60

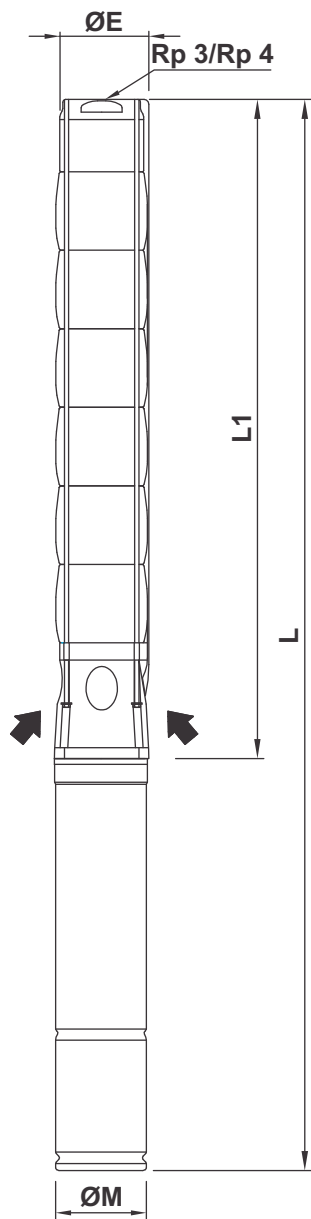

Performance chart

Pump type	Motor type	HP	kW	Q l/min USgpm	n = 3450 rpm						
					H ft.						
	Water filled				0	83	167	500	834	1167	1550
W60/9	L6635-KP	35.0	26.0	604	595	594	535	433	336	172	
W60/10	L6635-KP	35.0	26.0	679	673	669	605	492	384	202	
W60/11	L6640-KP	40.0	30.0	748	740	735	663	538	420	223	
W60/12	L6650-KP	50.0	37.0	823	814	809	733	595	466	246	
W60/13	L6650-KP	50.0	37.0	889	878	872	791	641	502	264	
W60/14	L6650-KP	50.0	37.0	951	942	937	846	689	541	289	
W60/15	L8660-KH	60.0	45.0	1038	1027	1022	928	758	597	328	
W60/16	L8660-KH	60.0	45.0	1106	1093	1088	989	809	633	349	
W60/17	L8660-KH	60.0	45.0	1171	1158	1153	1050	855	673	371	
W60/18	L8675-KH	75.0	55.0	1252	1239	1230	1122	919	722	397	
W60/19	L8675-KH	75.0	55.0	1319	1306	1298	1181	968	761	418	
W60/20	L8675-KH	75.0	55.0	1386	1371	1362	1243	1017	797	440	
W60/21	L8690-H	90.0	66.0	1457	1442	1434	1306	1066	840	463	

Dimensions & weights of pump with Water filled motor

Type Pump + Motor	ØM [inch]	ØE [inch]	Length [inch]		Gross weight [lbs]			Gross volume [ft³]			
			L1	L		Pump	Pump+Motor		Pump	Pump+Motor	
				1 ~	3 ~		1 ~	3 ~		1 ~	3 ~
W60/09 + L6635-KP	5.59	5.83	50.67	-	92.13	64	-	294	1.3	-	5.6
W60/10 + L6635-KP	5.59	5.83	55.12	-	96.57	70	-	299	1.3	-	5.6
W60/11 + L6640-KP	5.59	5.83	59.57	-	104.17	76	-	323	1.3	-	6.0
W60/12 + L6650-KP	5.59	5.83	67.17	-	113.74	82	-	356	1.6	-	6.3
W60/13 + L6650-KP	5.59	5.83	71.61	-	118.19	88	-	361	1.6	-	6.3
W60/14 + L6650-KP	5.59	5.83	76.18	-	122.76	94	-	367	1.6	-	6.3
W60/15 + L8660-KH	7.48	7.48	78.62	-	126.34	142	-	614	5.2	-	12.7
W60/16 + L8660-KH	7.48	7.48	83.07	-	130.79	151	-	623	5.4	-	13.0
W60/17 + L8660-KH	7.48	7.48	87.52	-	135.24	158	-	630	5.7	-	13.2
W60/18 + L8675-KH	7.48	7.48	91.97	-	141.65	166	-	669	6.0	-	13.8
W60/19 + L8675-KH	7.48	7.48	102.83	-	152.52	174	-	677	6.3	-	14.0
W60/20 + L8675-KH	7.48	7.48	107.28	-	156.97	182	-	685	6.5	-	14.3
W60/21 + L8690-H	7.48	7.48	111.73	-	168.15	190	-	778	6.8	-	15.4

Note: ØE = For single cable motor maximum diameter of pump inclusive of cable guard.
For two cable motor maximum diameter of pump inclusive of cable guard will increase by 0.12 inch.

All dimensions in inches unless otherwise noted.

Performance curves

Mixed flow 6" stainless steel submersible bore well pumps

W60

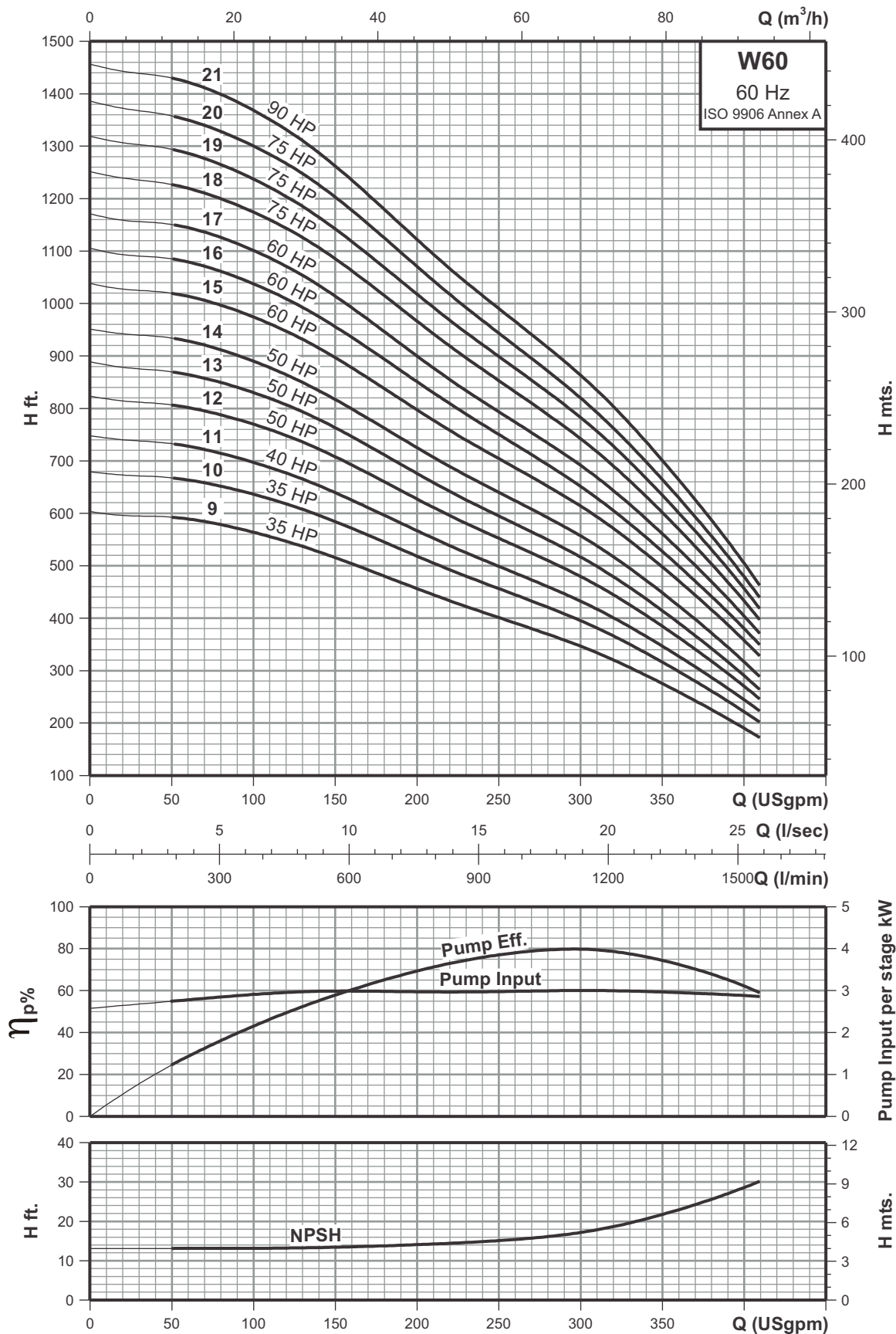

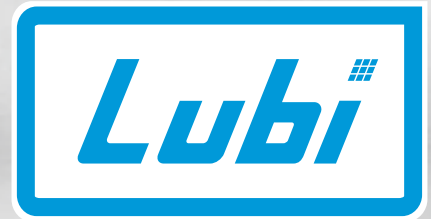

Submersible

Pumps • Motors

60Hz **8"**
Submersible Pump

Pumping Solution

Product data

8"

Stainless steel submersible bore well pumps

Construction

- Submersible motor & pumps for deep wells of 8" (DN 200 mm).
- Sized for connection to the motor according to NEMA standards.
- Delivery casing with built-in non-return valve.
- All standard pumps are completely manufactured out of stainless steel AISI 304 sheet metal.
- Impellers:**
 - Mixed flow impellers**
 - W77, W95
- Connection: Screwed pipe connection with NPT thread as standard.

Applications

- Water supply
- Irrigation
- Civil
- Industrial
- Fire fighting

Performance range

- Flow range: Max. 660 USgpm
- Head range: Max. 1427 feet

Operating conditions

- Liquid temperature: +32°F to +113°F
- Max. sand content into the water: 50 g/m³
- Max. starts per hour: 20 at regular intervals
- Direction of rotation: Clockwise as seen from the pump coupling side

Special construction on request

- Also available in stainless steel AISI 316 material.
- Also available with BSP thread pipe connection.



Construction

Stainless steel submersible bore well pumps

8"

Sectional drawing

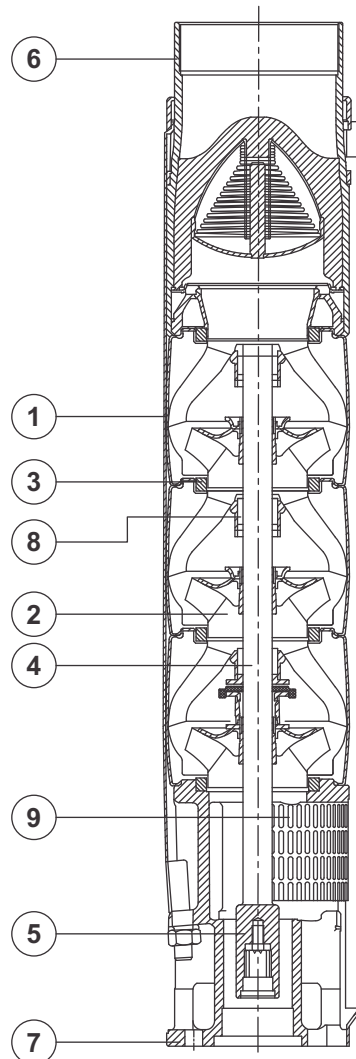

**“W” type pump
W77, W95**

Materials

Pos.	Component	Material
1	Bowl / Diffuser	Stainless steel AISI 304
2	Impeller	Stainless steel AISI 304
3	Neck ring	NBR
4	Shaft	Stainless steel AISI 431
5	Couple	Stainless steel AISI 304
6	Delivery casing	Stainless steel AISI 304
7	Suction case	Stainless steel AISI 304
8	Bearing bush	NBR
9	Strainer	Stainless steel AISI 304

Technical data

Mixed flow 8" stainless steel submersible bore well pumps

W77

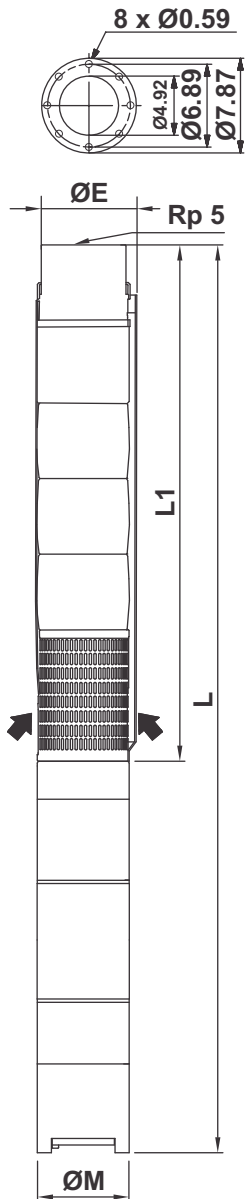

Performance chart

Pump type	Motor type	HP	kW	Q l/min	n = 3450 rpm							
					Water filled							
	USgpm	0	167	333	833	1167	1500	1667	2000			
W77/1	L6607	7.50	5.50	H ft.	99	97	94	76	66	56	51	32
W77/2-BA	L6610-KP	10.0	7.50		125	125	123	106	89	66	52	13
W77/2-A	L6612-KP	12.5	9.30		164	161	157	134	115	93	79	39
W77/2	L6615-KP	15.0	11.0		194	191	187	157	136	116	102	65
W77/3-AA	L6617-KP	17.5	13.0		229	226	222	190	164	130	107	47
W77/3-A	L6620-KP	20.0	15.0		259	257	252	213	184	154	131	73
W77/3	L6625-KP	25.0	18.5		290	289	283	240	210	179	157	101
W77/4-B	L6625-KP	25.0	18.5		346	344	338	288	249	207	178	102
W77/4	L6630-KP	30.0	22.0		383	381	374	318	276	236	209	131
W77/5-BB	L6630-KP	30.0	22.0		405	400	394	338	290	239	202	108
W77/5	L6635-KP	35.0	26.0		480	479	471	400	349	299	263	167

Dimensions & weights of pump with Water filled motor

Type Pump + Motor	ØM [inch]	ØE [inch]	Length [inch]			Gross weight [lbs]				Gross volume [ft³]		
			L1	L		Pump	Pump+Motor		Pump	Pump+Motor		
				1 ~	3 ~		1 ~	3 ~		1 ~	3 ~	
W77/1 + L6607	5.59	7.01	24.33	-	51.02	76	-	186	2.5	-	3.4	
W77/2-BA + L6610-KP	5.59	7.01	29.37	-	57.24	87	-	206	2.9	-	3.8	
W77/2-A + L6612-KP	5.59	7.01	29.37	-	59.21	87	-	218	2.9	-	3.8	
W77/2 + L6615-KP	5.59	7.01	29.37	-	60.79	87	-	228	2.9	-	4.0	
W77/3-AA + L6617-KP	5.59	7.01	34.41	-	67.20	103	-	252	3.3	-	4.4	
W77/3-A + L6620-KP	5.59	7.01	34.41	-	68.39	103	-	257	3.3	-	4.4	
W77/3 + L6625-KP	5.59	7.01	34.41	-	71.14	103	-	275	3.3	-	4.4	
W77/4-B + L6625-KP	5.59	7.01	39.45	-	76.18	114	-	286	3.8	-	4.9	
W77/4 + L6630-KP	5.59	7.01	39.45	-	78.54	114	-	299	3.8	-	4.9	
W77/5-BB + L6630-KP	5.59	7.01	44.49	-	83.58	123	-	309	4.2	-	5.3	
W77/5 + L6635-KP	5.59	7.01	44.49	-	85.94	123	-	353	4.2	-	8.5	

Note: ØE = For single cable motor maximum diameter of pump inclusive of cable guard.
 For two cable motor maximum diameter of pump inclusive of cable guard will increase by 0.16 inch.
 Flange connection is available on request.
 All dimensions in inches unless otherwise noted.

Performance curves

Mixed flow 8" stainless steel submersible bore well pumps

W77

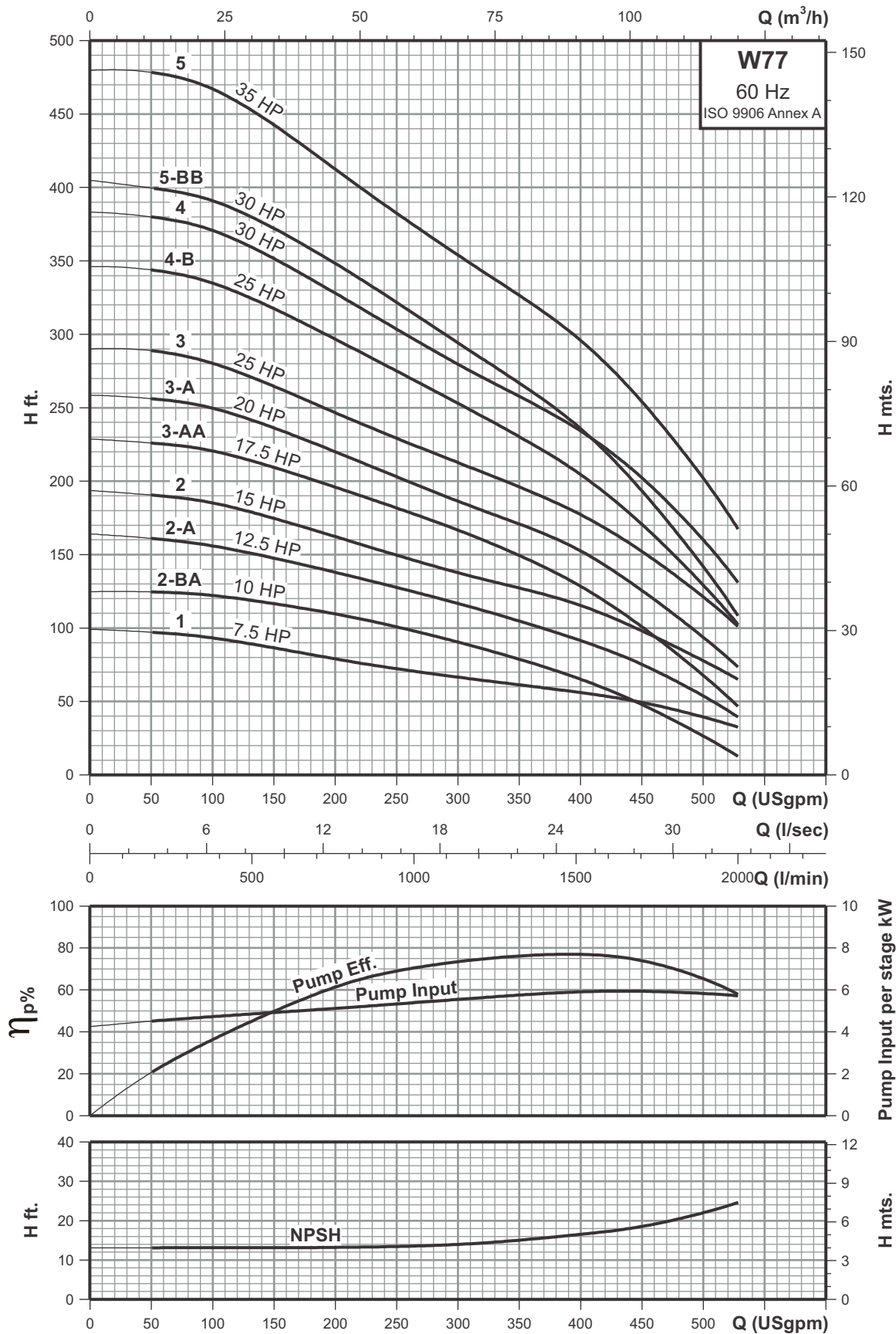

Technical data

Mixed flow 8" stainless steel submersible bore well pumps

W77

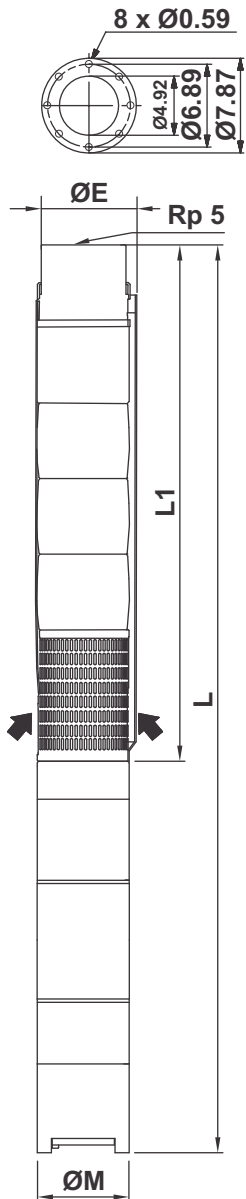

Performance chart

Pump type	Motor type	HP	kW	Q l/min	n = 3450 rpm							
					Water filled							
	USgpm	0	167	333	833	1167	1500	1667	2000			
W77/6-B	L6640-KP	40.0	30.0	H ft.	536	534	525	449	387	325	284	167
W77/6	L6650-KP	50.0	37.0		574	574	566	484	422	361	320	205
W77/7	L6650-KP	50.0	37.0		664	664	656	559	486	415	367	235
W77/8	L8660-KH	60.0	45.0		764	768	755	650	571	487	435	279
W77/9	L8675-KH	75.0	55.0		866	869	855	738	646	556	495	322
W77/10	L8675-KH	75.0	55.0		958	961	948	817	714	614	548	353
W77/11	L8690-H	90.0	66.0		1053	1056	1043	899	787	673	599	387
W77/12	L8690-H	90.0	66.0		1147	1148	1132	974	853	730	646	418
W77/13	L86100-H	100.0	75.0		1245	1248	1234	1063	932	796	707	459
W77/14	L86125-H	125.0	93.0		1337	1342	1322	1140	997	853	755	487
W77/15	L86125-H	125.0	93.0		1427	1434	1414	1216	1066	909	807	517

Dimensions & weights of pump with Water filled motor

Type Pump + Motor	ØM [inch]	ØE [inch]	Length [inch]			Gross weight [lbs]			Gross volume [ft³]		
			L1	L		Pump	Pump+Motor		Pump	Pump+Motor	
				1 ~	3 ~		1 ~	3 ~		1 ~	3 ~
W77/6-B + L6640-KP	5.59	7.01	49.53	-	94.13	134	-	381	4.6	-	9.3
W77/6 + L6650-KP	5.59	7.01	49.53	-	96.10	134	-	408	4.6	-	9.3
W77/7 + L6650-KP	5.59	7.01	54.57	-	101.14	144	-	418	5.1	-	9.8
W77/8 + L8660-KH	7.48	7.87	60.16	-	107.87	155	-	627	5.5	-	13.0
W77/9 + L8675-KH	7.48	7.87	65.20	-	114.88	164	-	667	5.9	-	13.7
W77/10 + L8675-KH	7.48	7.87	70.24	-	119.92	176	-	679	6.4	-	14.2
W77/11 + L8690-H	7.48	7.87	75.28	-	131.69	185	-	774	6.8	-	15.4
W77/12 + L8690-H	7.48	7.87	80.31	-	136.73	196	-	785	7.2	-	15.8
W77/13 + L86100-H	7.48	7.87	85.35	-	143.62	207	-	820	7.7	-	16.5
W77/14 + L86125-H	7.48	7.87	102.20	-	165.98	218	-	891	8.1	-	17.6
W77/15 + L86125-H	7.48	7.87	107.24	-	171.02	227	-	899	8.5	-	18.0

Note: ØE = For single cable motor maximum diameter of pump inclusive of cable guard.
 For two cable motor maximum diameter of pump inclusive of cable guard will increase by 0.16 inch.
 Flange connection is available on request.
 All dimensions in inches unless otherwise noted.

Performance curves

Mixed flow 8" stainless steel submersible bore well pumps

W77

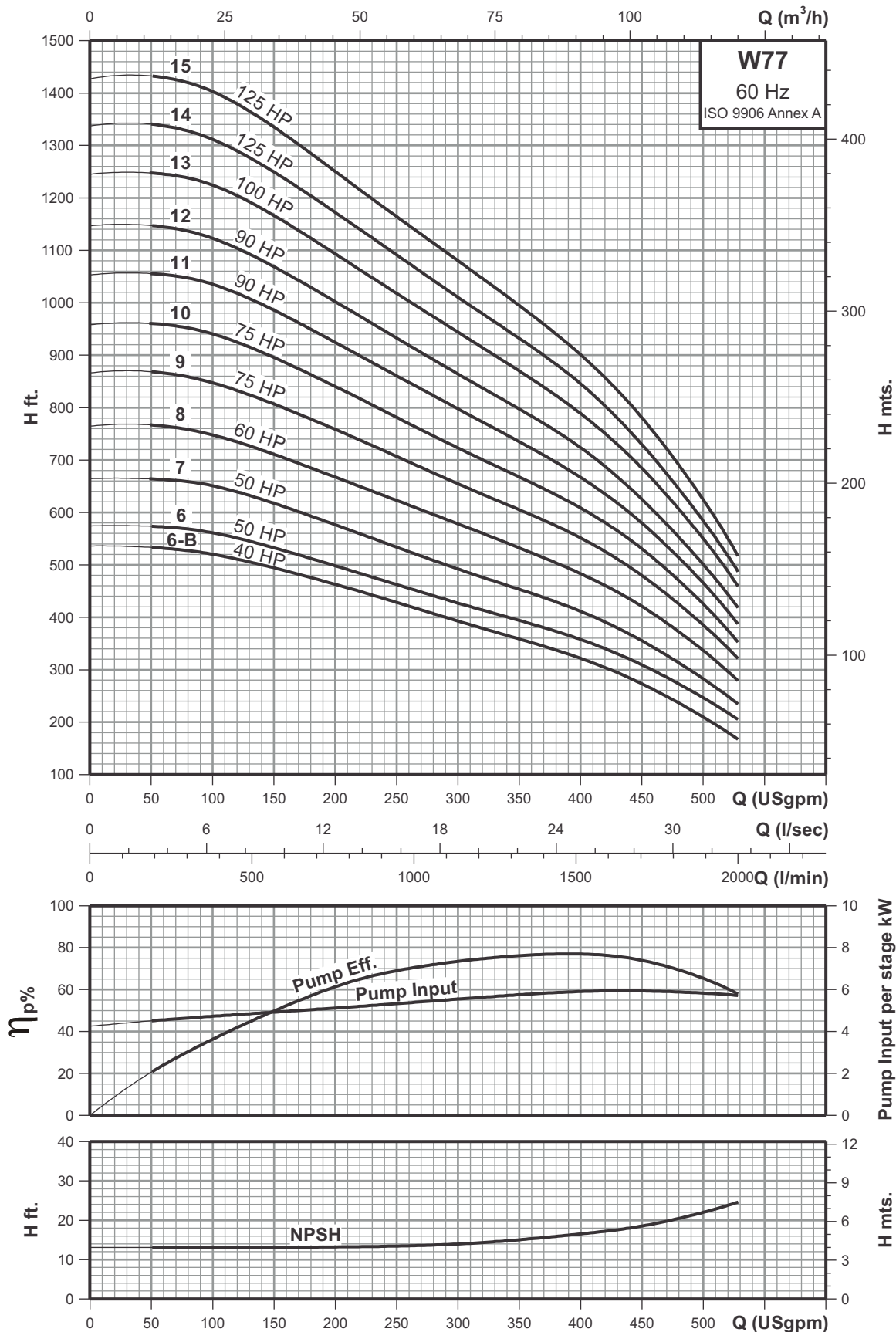

Technical data

Mixed flow 8" stainless steel submersible bore well pumps

W95

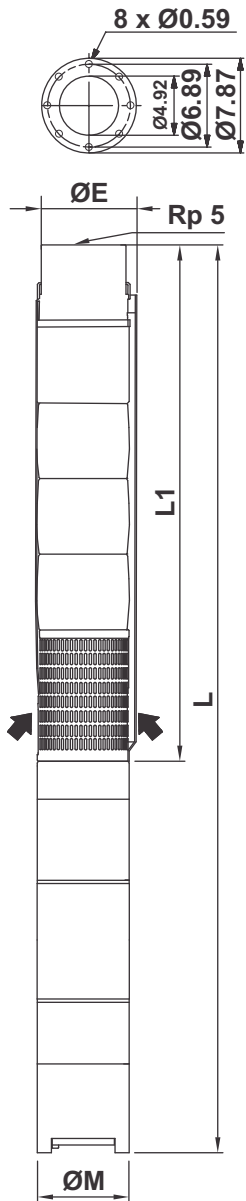

Performance chart

Pump type	Motor type	HP	kW	Q l/min	n = 3450 rpm						
					Water filled						
	USgpm	0	167	333	1333	1667	2000	2500			
W95/1-A	L6607	7.50	5.50	H ft.	77	77	75	52	47	33	7
W95/1	L6610-KP	10.0	7.50		107	103	100	67	60	49	25
W95/2-AB	L6612-KP	12.5	9.30		138	138	135	98	83	56	10
W95/2-B	L6615-KP	15.0	11.0		171	167	161	114	98	74	30
W95/2	L6617-KP	17.5	13.0		209	206	200	142	128	105	56
W95/3-BB	L6620-KP	20.0	15.0		233	229	222	159	136	98	33
W95/3-B	L6625-KP	25.0	18.5		272	267	260	188	164	131	59
W95/3	L6630-KP	30.0	22.0		309	304	296	216	193	159	85
W95/4-AB	L6630-KP	30.0	22.0		348	341	334	243	213	164	72
W95/4	L6635-KP	35.0	26.0		410	405	396	289	259	213	115

Dimensions & weights of pump with Water filled motor

Type Pump + Motor	ØM [inch]	ØE [inch]	Length [inch]			Gross weight [lbs]			Gross volume [ft³]		
			L1	L		Pump	Pump+Motor		Pump	Pump+Motor	
				1 ~	3 ~		1 ~	3 ~		1 ~	3 ~
W95/1-A + L6607	5.59	7.01	24.33	-	51.02	76	-	186	2.5	-	3.4
W95/1 + L6610-KP	5.59	7.01	24.33	-	52.20	76	-	195	2.5	-	3.4
W95/2-AB + L6612-KP	5.59	7.01	29.37	-	59.21	87	-	218	2.9	-	3.8
W95/2-B + L6615-KP	5.59	7.01	29.37	-	60.79	87	-	228	2.9	-	4.0
W95/2 + L6617-KP	5.59	7.01	29.37	-	62.17	87	-	237	2.9	-	4.0
W95/3-BB + L6620-KP	5.59	7.01	34.41	-	68.39	103	-	257	3.3	-	4.4
W95/3-B + L6625-KP	5.59	7.01	34.41	-	71.14	103	-	275	3.3	-	4.4
W95/3 + L6630-KP	5.59	7.01	34.41	-	73.50	103	-	288	3.3	-	4.4
W95/4-AB + L6630-KP	5.59	7.01	39.45	-	78.54	114	-	299	3.8	-	4.9
W95/4 + L6635-KP	5.59	7.01	39.45	-	80.91	114	-	343	3.8	-	8.1

Note: ØE = For single cable motor maximum diameter of pump inclusive of cable guard.
 For two cable motor maximum diameter of pump inclusive of cable guard will increase by 0.16 inch.
 Flange connection is available on request.
 All dimensions in inches unless otherwise noted.

Performance curves

Mixed flow 8" stainless steel submersible bore well pumps

W95

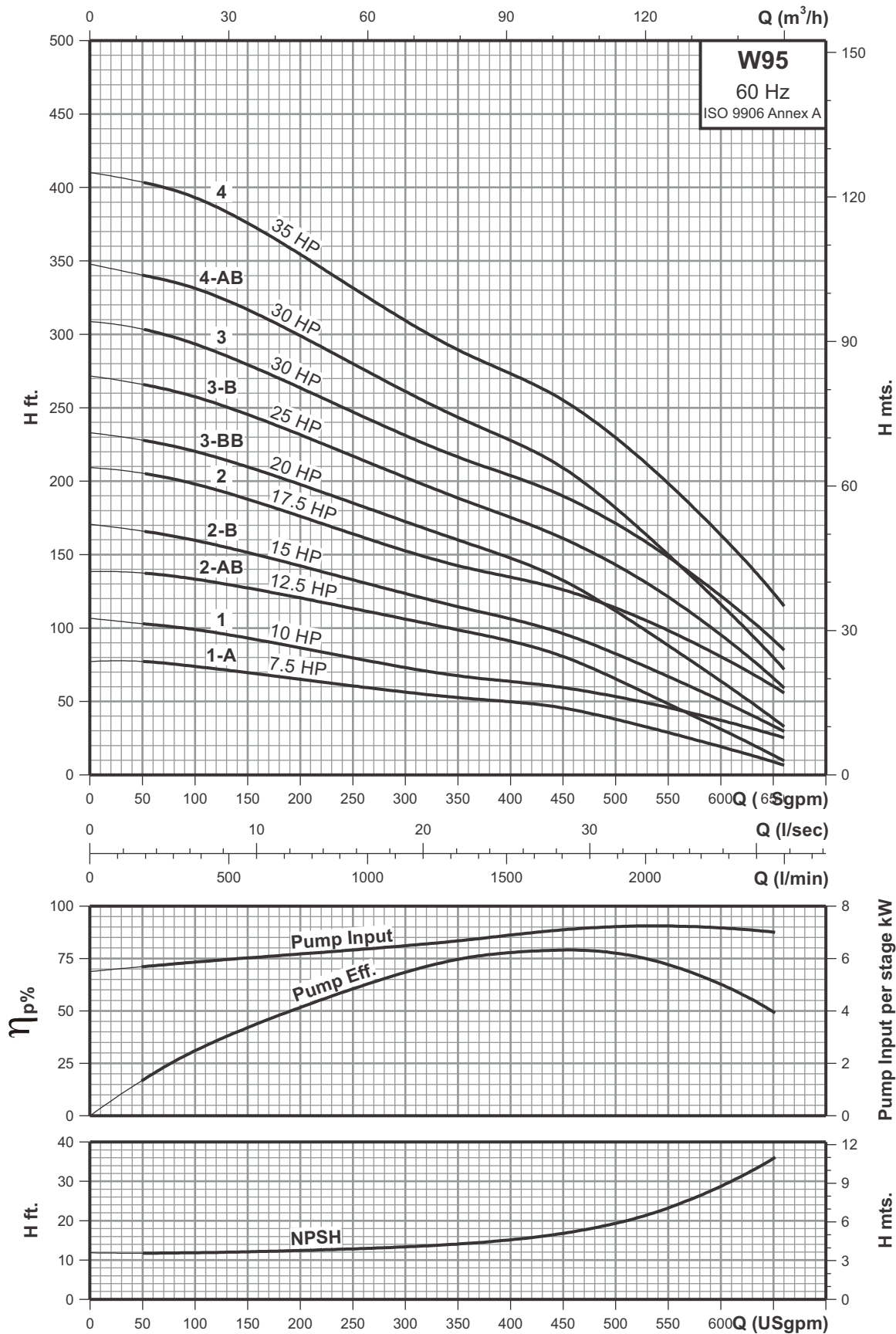

Technical data

Mixed flow 8" stainless steel submersible bore well pumps

W95

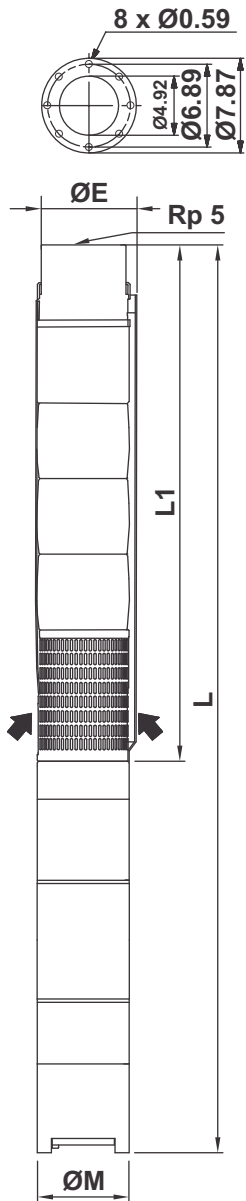

Performance chart

Pump type	Motor type	HP	kW	Q l/min	n = 3450 rpm						
					Water filled						
	USgpm	0	167	333	1333	1667	2000	2500			
W95/5-B	L6640-KP	40.0	30.0	H ft.	469	463	453	331	292	233	115
W95/5	L6650-KP	50.0	37.0		510	502	492	361	326	271	146
W95/6	L6650-KP	50.0	37.0		604	597	584	430	384	318	167
W95/7	L8660-KH	60.0	45.0		712	705	691	515	459	381	207
W95/8	L8675-KH	75.0	55.0		815	810	794	591	531	443	243
W95/9	L8690-H	90.0	66.0		917	909	892	664	597	492	272
W95/10	L8690-H	90.0	66.0		1012	1006	984	732	659	545	295
W95/11	L86100-H	100.0	75.0		1115	1107	1089	810	728	607	330
W95/12	L86125-H	125.0	93.0		1214	1204	1181	876	791	656	354
W95/13	L86125-H	125.0	93.0		1309	1296	1273	948	851	705	381

Dimensions & weights of pump with Water filled motor

Type Pump + Motor	ØM [inch]	ØE [inch]	Length [inch]			Gross weight [lbs]			Gross volume [ft³]		
			L1	L		Pump	Pump+Motor		Pump	Pump+Motor	
				1 ~	3 ~		1 ~	3 ~		1 ~	3 ~
W95/5-B + L6640-KP	5.59	7.01	44.49	-	89.09	123	-	370	4.2	-	8.9
W95/5 + L6650-KP	5.59	7.01	44.49	-	91.06	123	-	397	4.2	-	8.9
W95/6 + L6650-KP	5.59	7.01	49.53	-	96.10	134	-	408	4.6	-	9.3
W95/7 + L8660-KH	7.48	7.87	55.12	-	102.83	144	-	616	5.1	-	12.6
W95/8 + L8675-KH	7.48	7.87	60.16	-	109.84	155	-	658	5.5	-	13.3
W95/9 + L8690-H	7.48	7.87	65.20	-	121.61	164	-	753	5.9	-	14.5
W95/10 + L8690-H	7.48	7.87	70.24	-	126.65	176	-	765	6.4	-	14.9
W95/11 + L86100-H	7.48	7.87	75.28	-	133.54	185	-	798	6.8	-	15.6
W95/12 + L86125-H	7.48	7.87	80.31	-	144.09	196	-	869	7.2	-	16.7
W95/13 + L86125-H	7.48	7.87	85.35	-	149.13	207	-	880	7.7	-	17.2

Note: ØE = For single cable motor maximum diameter of pump inclusive of cable guard.

For two cable motor maximum diameter of pump inclusive of cable guard will increase by 0.16 inch.

Flange connection is available on request.

All dimensions in inches unless otherwise noted.

Performance curves

Mixed flow 8" stainless steel submersible bore well pumps

W95

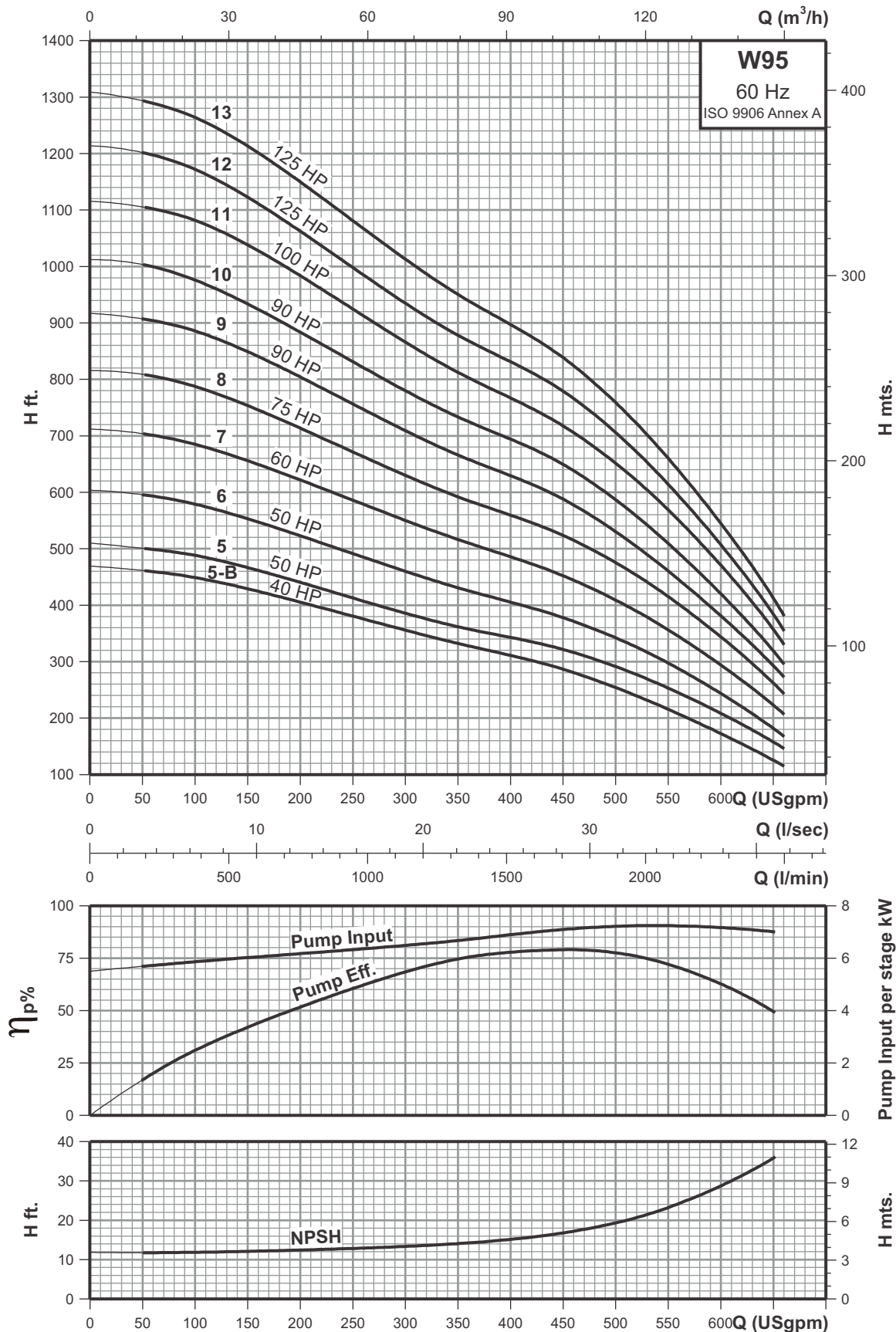

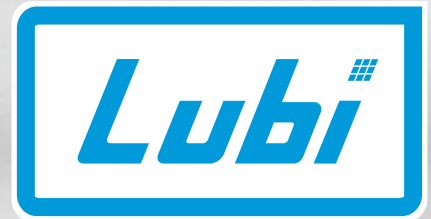

Submersible

Pumps • Motors

60Hz **10''**
Submersible Pump

Pumping Solution

Product data

10''

Stainless steel submersible bore well pumps

Construction

- Submersible motor & pumps for deep wells of 10'' (DN 250 mm).
- Sized for connection to the motor according to NEMA standards up to 8'' motor joining.
- Delivery casing with built-in non-return valve.
- All standard pumps are completely manufactured out of stainless steel AISI 304 sheet metal.
- Impellers:**
 - Mixed flow impellers**
 - W125, W160, W215
- Connection: Screwed pipe connection with NPT thread as standard.

Applications

- Water supply
- Irrigation
- Civil
- Industrial
- Fire fighting

Performance range

- Flow range: Max. 1475 USgpm
- Head range: Max. 1772 feet

Operating conditions

- Liquid temperature: +32°F to +113°F
- Max. sand content into the water: 50 g/m³
- Max. starts per hour: 20 at regular intervals
- Direction of rotation: Clockwise as seen from the pump coupling side

Special construction on request

- Also available in stainless steel AISI 316 material.
- Also available with BSP thread pipe connection.



Construction

Stainless steel submersible bore well pumps

10''

Sectional drawing

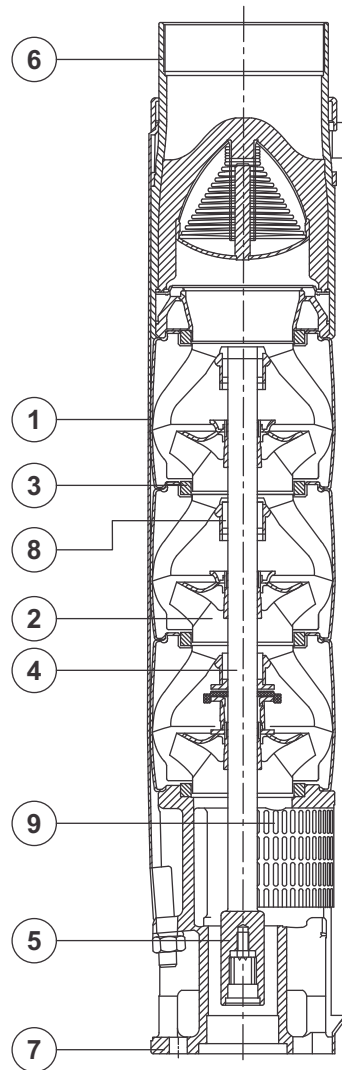

"W" type pump
W125, W160, W215

Materials

Pos.	Component	Material
1	Bowl / Diffuser	Stainless steel AISI 304
2	Impeller	Stainless steel AISI 304
3	Neck ring	NBR
4	Shaft	Stainless steel AISI 431
5	Couple	Stainless steel AISI 304
6	Delivery casing	Stainless steel AISI 304
7	Suction case	Stainless steel AISI 304
8	Bearing bush	NBR
9	Strainer	Stainless steel AISI 304

Technical data

Mixed flow 10" stainless steel submersible bore well pumps

W125

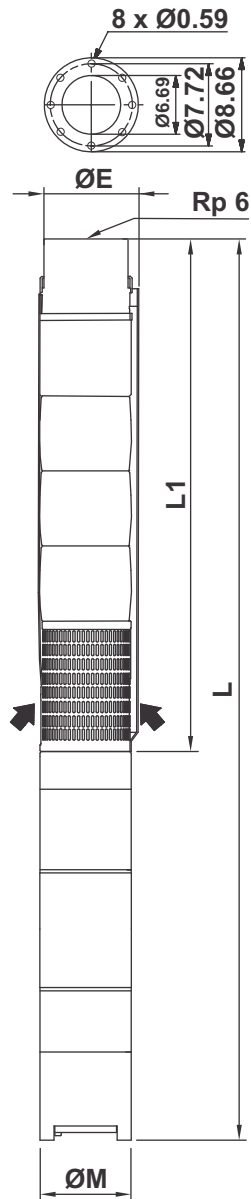

Performance chart

Pump type	Motor type	HP	kW	Q	n = 3450 rpm					
					l/min	0	333	1000	1667	2334
	Water filled	USgpm	0	88	264	440	617	859		
W125/1-A	L6615-KP	15.0	11.0	H ft.	100	101	92	82	68	26
W125/1	L6625-KP	25.0	18.5		145	145	133	115	99	62
W125/2-AA	L6630-KP	30.0	22.0		191	197	184	164	136	49
W125/2-A	L6635-KP	35.0	26.0		236	240	223	198	167	85
W125/2	L6640-KP	40.0	30.0		280	284	262	232	200	123
W125/3-AA	L6650-KP	50.0	37.0		325	335	315	280	235	108
W125/3-A	L6650-KP	50.0	37.0		371	377	353	313	266	144
W125/3	L8660-KH	60.0	45.0		418	425	400	354	308	195
W125/4-AA	L8675-KH	75.0	55.0		466	477	453	407	347	182
W125/4-A	L8675-KH	75.0	55.0		511	522	492	440	381	221
W125/4	L8690-H	90.0	66.0		557	566	533	476	415	262
W125/5-AA	L86100-H	100.0	75.0		604	617	584	525	449	246
W125/5-A	L86100-H	100.0	75.0		646	659	623	561	486	289
W125/5	L86100-H	100.0	75.0		686	705	664	594	518	326

Dimensions & weights of pump with Water filled motor

Type Pump + Motor	ØM [inch]	ØE [inch]	Length [inch]		Gross weight [lbs]			Gross volume [ft³]			
			L1	L		Pump	Pump+Motor		Pump	Pump+Motor	
				1 ~	3 ~		1 ~	3 ~		1 ~	3 ~
W125/1-A + L6615-KP	5.59	8.31	25.67	-	57.09	101	-	242	3.1	-	4.2
W125/1 + L6625-KP	5.59	8.31	25.67	-	62.40	101	-	274	3.1	-	4.2
W125/2-AA + L6630-KP	5.59	8.31	31.77	-	70.87	115	-	300	3.8	-	4.9
W125/2-A + L6635-KP	5.59	8.31	31.77	-	73.23	115	-	344	3.8	-	8.1
W125/2 + L6640-KP	5.59	8.31	31.77	-	76.38	115	-	362	3.8	-	8.5
W125/3-AA + L6650-KP	5.59	8.31	37.91	-	84.49	130	-	403	4.4	-	9.1
W125/3-A + L6650-KP	5.59	8.31	37.91	-	84.49	130	-	403	4.4	-	9.1
W125/3 + L8660-KH	7.48	8.39	37.91	-	85.63	130	-	602	4.4	-	12.0
W125/4-AA + L8675-KH	7.48	8.39	44.02	-	93.70	146	-	648	5.1	-	12.9
W125/4-A + L8675-KH	7.48	8.39	44.02	-	93.70	146	-	648	5.1	-	12.9
W125/4 + L8690-H	7.48	8.39	44.02	-	100.43	146	-	734	5.1	-	13.7
W125/5-AA + L86100-H	7.48	8.39	50.16	-	108.43	165	-	778	6.0	-	14.8
W125/5-A + L86100-H	7.48	8.39	50.16	-	108.43	165	-	778	6.0	-	14.8
W125/5 + L86100-H	7.48	8.39	50.16	-	108.43	165	-	778	6.0	-	14.8

Note: ØE = For single cable motor maximum diameter of pump inclusive of cable guard.
For two cable motor maximum diameter of pump inclusive of cable guard will increase by 0.24 inch.

Flange connection is available on request.

All dimensions in inches unless otherwise noted.

Performance curves

Mixed flow 10" stainless steel submersible bore well pumps

W125

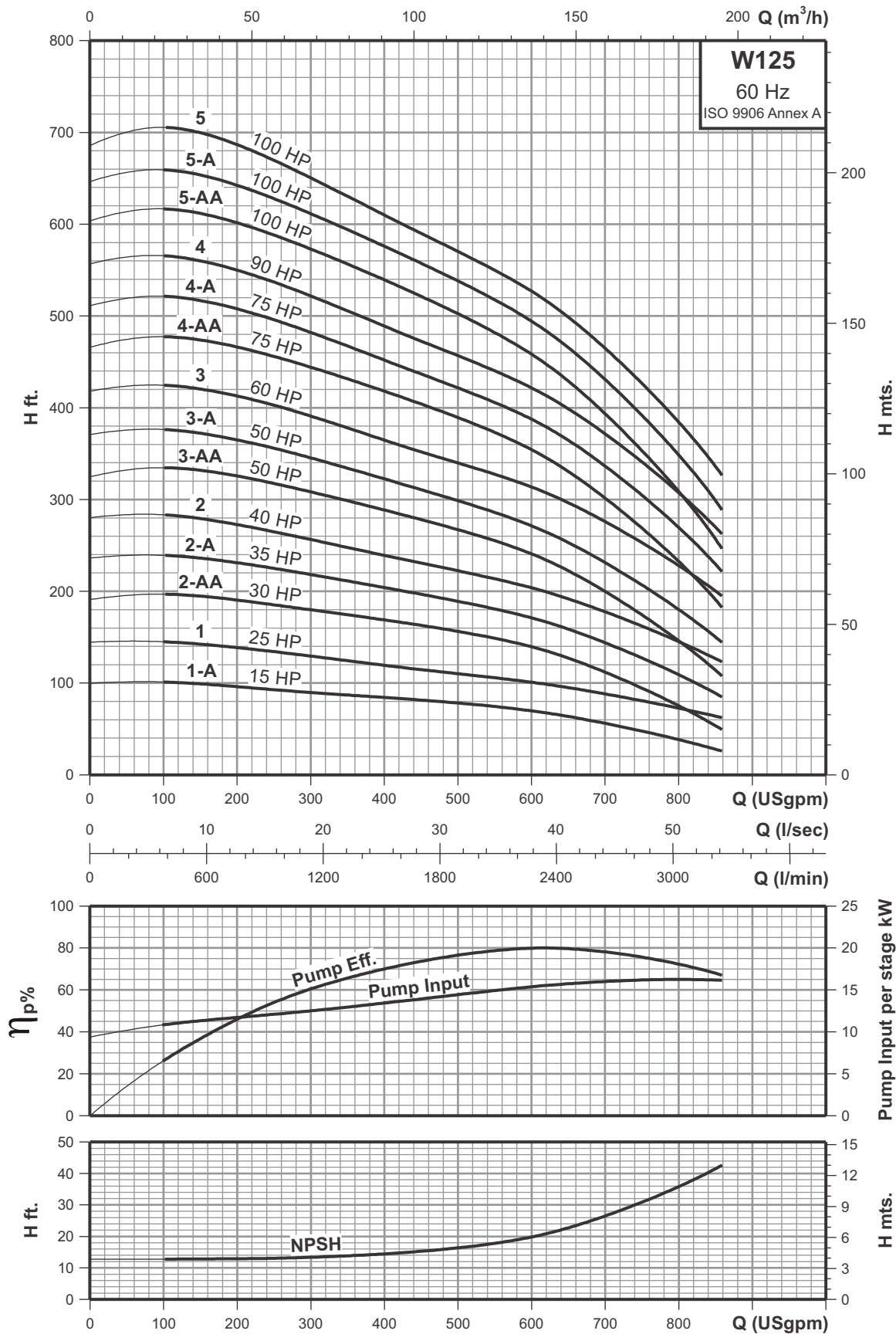

Technical data

Mixed flow 10" stainless steel submersible bore well pumps

W125

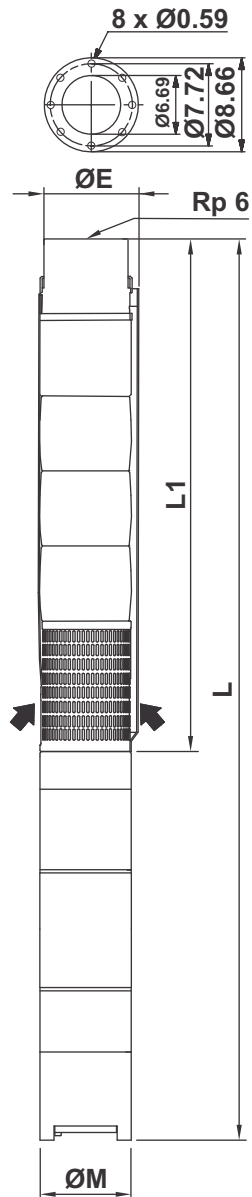

Performance chart

Pump type	Motor type	HP	kW	Q	n = 3450 rpm					
					I/min	0	333	1000	1667	2334
	Water filled	USgpm	0	88	264	440	617	859		
W125/6-AA	L86100-H	100.0	75.0	H ft.	738	755	714	640	548	308
W125/6-A	L86125-H	125.0	93.0		781	796	755	673	581	344
W125/6	L86125-H	125.0	93.0		825	837	791	705	615	384
W125/7-AA	L86125-H	125.0	93.0		869	884	838	753	643	361
W125/7-A	L86125-H	125.0	93.0		912	928	876	784	679	400
W125/7	L86150-H	150.0	110.0		961	978	925	827	722	449
W125/8	L16180-D	180.0	135.0		1106	1129	1070	958	840	536
W125/9	L16180-D	180.0	135.0		1242	1263	1198	1070	942	597
W125/10	L16200-D	200.0	150.0		1385	1411	1339	1198	1053	673
W125/11	L16225-D	225.0	165.0		1521	1549	1476	1319	1165	741
W125/12	L16250-D	250.0	185.0		1640	1670	1581	1411	1230	763
W125/13	L16250-D	250.0	185.0		1772	1801	1706	1512	1316	810

Dimensions & weights of pump with Water filled motor

Type Pump + Motor	ØM [inch]	ØE [inch]	Length [inch]			Gross weight [lbs]			Gross volume [ft³]		
			L1	L		Pump	Pump+Motor		Pump	Pump+Motor	
				1 ~	3 ~		1 ~	3 ~		1 ~	3 ~
W125/6-AA + L86100-H	7.48	8.39	56.26	-	114.53	181	-	794	6.6	-	15.5
W125/6-A + L86125-H	7.48	8.39	56.26	-	120.04	181	-	853	6.6	-	16.1
W125/6 + L86125-H	7.48	8.39	56.26	-	120.04	181	-	853	6.6	-	16.1
W125/7-AA + L86125-H	7.48	8.39	62.40	-	126.18	196	-	869	7.3	-	16.8
W125/7-A + L86125-H	7.48	8.39	62.40	-	126.18	196	-	869	7.3	-	16.8
W125/7 + L86150-H	7.48	8.39	62.40	-	131.30	196	-	950	7.3	-	17.5
W125/8 + L16180-D	9.45	9.45	82.36	-	154.25	216	-	1140	8.2	-	20.9
W125/9 + L16180-D	9.45	9.45	88.50	-	160.39	231	-	1155	8.9	-	21.5
W125/10 + L16200-D	9.45	9.45	94.61	-	168.07	247	-	1202	9.5	-	22.2
W125/11 + L16225-D	9.45	9.45	100.75	-	176.18	267	-	1261	10.4	-	23.6
W125/12 + L16250-D	9.45	9.45	109.96	-	187.36	280	-	1321	11.1	-	25.1
W125/13 + L16250-D	9.45	9.45	116.06	-	193.46	295	-	1336	11.7	-	25.7

Note: ØE = For single cable motor maximum diameter of pump inclusive of cable guard.
For two cable motor maximum diameter of pump inclusive of cable guard will increase by 0.24 inch.

Flange connection is available on request.
All dimensions in inches unless otherwise noted.

Performance curves

Mixed flow 10" stainless steel submersible bore well pumps

W125

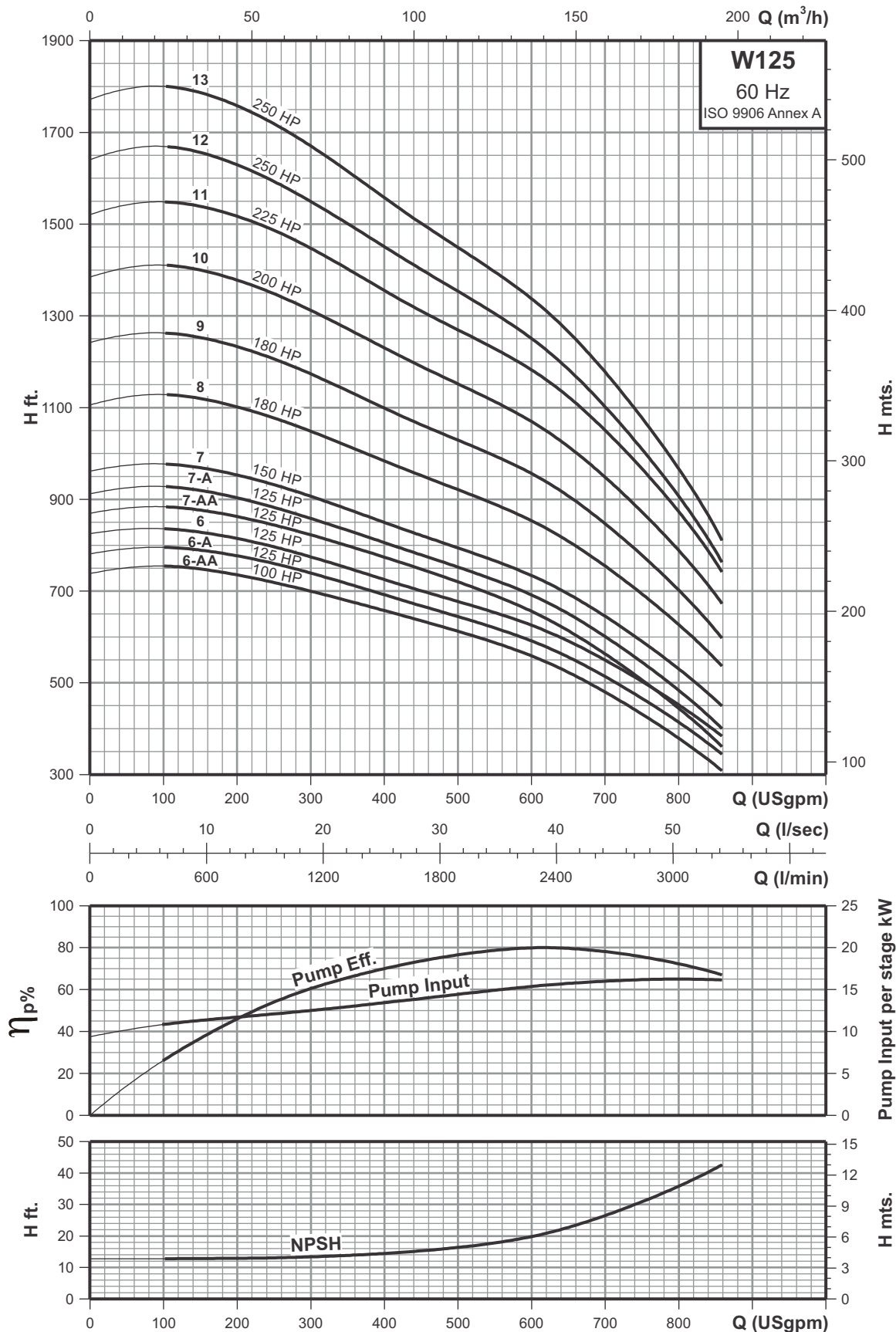

Technical data

Mixed flow 10" stainless steel submersible bore well pumps

W160

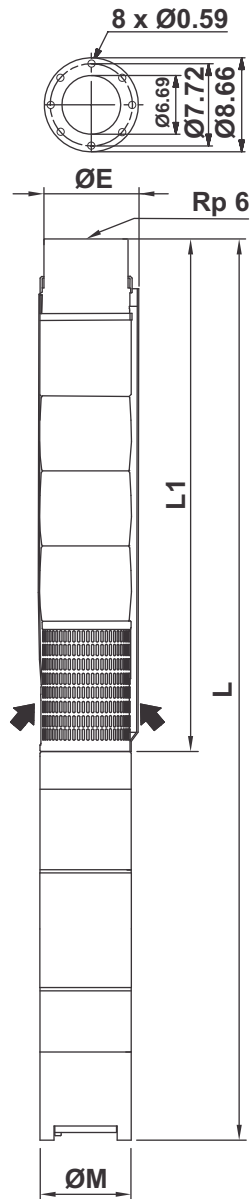

Performance chart

Pump type	Motor type	HP	kW	Q l/min	n = 3450 rpm					
					Water filled					
	USgpm	0	333	1333	2334	3334	4168			
W160/1-A	L6620-KP	20.0	15.0	H ft.	116	114	95	79	57	19
W160/1	L6630-KP	30.0	22.0		160	161	141	112	92	60
W160/2-AA	L6635-KP	35.0	26.0		220	217	191	161	118	45
W160/2-A	L6650-KP	50.0	37.0		263	266	240	195	154	88
W160/2	L6650-KP	50.0	37.0		308	309	276	223	184	121
W160/3-AA	L8660-KH	60.0	45.0		364	371	338	281	217	117
W160/3-A	L8675-KH	75.0	55.0		417	420	380	315	256	162
W160/3	L8675-KH	75.0	55.0		462	466	417	344	285	190
W160/4-AA	L8690-H	90.0	66.0		518	525	476	394	312	180
W160/4-A	L86100-H	100.0	75.0		566	571	517	427	348	223
W160/4	L86100-H	100.0	75.0	614	617	551	459	381	254	
W160/5-AA	L86125-H	125.0	93.0	666	673	607	509	404	243	
W160/5-A	L86125-H	125.0	93.0	712	719	646	538	436	277	
W160/5	L86125-H	125.0	93.0	753	761	681	568	466	305	
W160/6	L86150-H	150.0	110.0	904	914	820	679	558	374	
W160/7	L16180-D	180.0	135.0	1063	1076	968	807	666	453	
W160/8	L16200-D	200.0	150.0	1217	1230	1112	928	768	522	
W160/9	L16225-D	225.0	165.0	1370	1385	1247	1043	866	587	
W160/10	L16250-D	250.0	185.0	1496	1511	1355	1129	919	604	

Dimensions & weights of pump with Water filled motor

Type Pump + Motor	ØM [inch]	ØE [inch]	Length [inch]		Gross weight [lbs]			Gross volume [ft³]			
			L1	L		Pump	Pump+Motor		Pump	Pump+Motor	
				1 ~	3 ~		1 ~	3 ~		1 ~	3 ~
W160/1-A + L6620-KP	5.59	8.31	25.67	-	59.65	101	-	256	3.1	-	4.2
W160/1 + L6630-KP	5.59	8.31	25.67	-	64.76	101	-	287	3.1	-	4.2
W160/2-AA + L6635-KP	5.59	8.31	31.77	-	73.23	115	-	344	3.8	-	8.1
W160/2-A + L6650-KP	5.59	8.31	31.77	-	78.35	115	-	388	3.8	-	8.5
W160/2 + L6650-KP	5.59	8.31	31.77	-	78.35	115	-	388	3.8	-	8.5
W160/3-AA + L8660-KH	7.48	8.39	37.91	-	85.63	130	-	602	4.4	-	12.0
W160/3-A + L8675-KH	7.48	8.39	37.91	-	87.60	130	-	633	4.4	-	12.2
W160/3 + L8675-KH	7.48	8.39	37.91	-	87.60	130	-	633	4.4	-	12.2
W160/4-AA + L8690-H	7.48	8.39	44.02	-	100.43	146	-	734	5.1	-	13.7
W160/4-A + L86100-H	7.48	8.39	44.02	-	102.28	146	-	758	5.1	-	13.9
W160/4 + L86100-H	7.48	8.39	44.02	-	102.28	146	-	758	5.1	-	13.9
W160/5-AA + L86125-H	7.48	8.39	50.16	-	113.94	165	-	838	6.0	-	15.5
W160/5-A + L86125-H	7.48	8.39	50.16	-	113.94	165	-	838	6.0	-	15.5
W160/5 + L86125-H	7.48	8.39	50.16	-	113.94	165	-	838	6.0	-	15.5
W160/6 + L86150-H	7.48	8.39	68.07	-	136.97	181	-	935	6.6	-	16.8
W160/7 + L16180-D	9.45	9.45	76.26	-	148.15	196	-	1120	7.3	-	20.0
W160/8 + L16200-D	9.45	9.45	82.36	-	155.83	216	-	1171	8.2	-	20.9
W160/9 + L16225-D	9.45	9.45	88.50	-	163.94	231	-	1226	8.9	-	22.1
W160/10 + L16250-D	9.45	9.45	97.72	-	175.12	247	-	1287	9.5	-	23.5

Note: ØE = For single cable motor maximum diameter of pump inclusive of cable guard.
For two cable motor maximum diameter of pump inclusive of cable guard will increase by 0.24 inch.

Flange connection is available on request.

All dimensions in inches unless otherwise noted.

Performance curves

Mixed flow 10" stainless steel submersible bore well pumps

W160

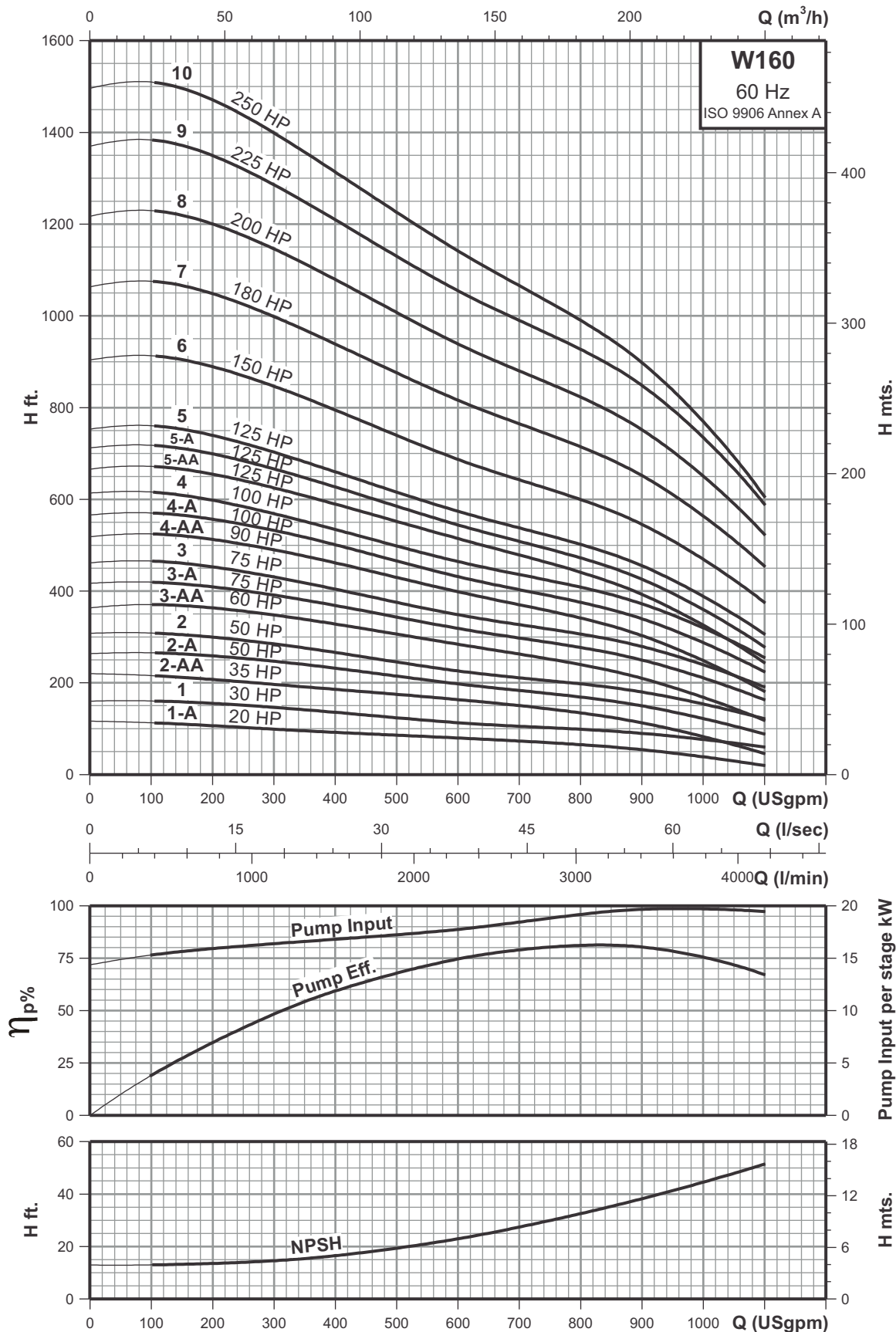

Technical data

Mixed flow 10" stainless steel submersible bore well pumps

W215

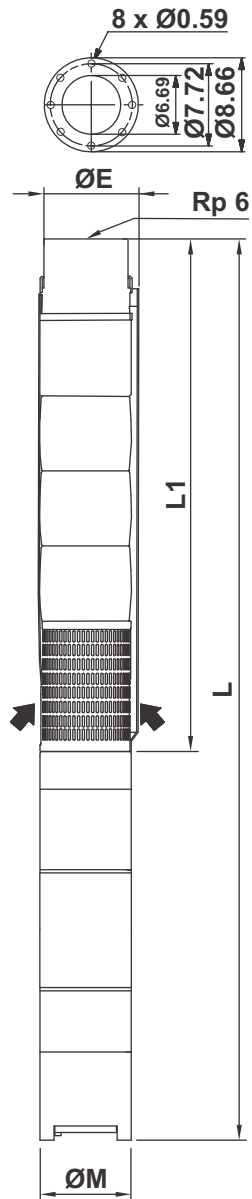

Performance chart

Pump type	Motor type	HP	kW	Q l/min	n = 3450 rpm						
					Water filled						
	USgpm	0	500	667	2000	3334	4668	5583			
W215/1-A	L6630-KP	30.0	22.0	H ft.	126	128	125	112	89	52	14
W215/1	L6640-KP	40.0	30.0		184	180	179	153	125	98	54
W215/2-AA	L8660-KH	60.0	45.0		259	258	257	237	200	133	59
W215/2-A	L8675-KH	75.0	55.0		318	315	313	281	239	183	98
W215/2	L8690-H	90.0	66.0		374	371	367	322	269	217	140
W215/3-AA	L86100-H	100.0	75.0		449	446	444	404	346	260	136
W215/3-A	L86125-H	125.0	93.0		503	500	498	443	374	292	175
W215/3	L86125-H	125.0	93.0		558	554	551	482	404	322	213
W215/4-AA	L86150-H	150.0	110.0		635	630	627	564	481	367	208
W215/4-A	L86150-H	150.0	110.0		687	684	681	602	509	400	249
W215/4	L86150-H	150.0	110.0		741	738	735	640	538	427	292
W215/5-AA	L16180-D	180.0	135.0		827	823	820	735	627	486	299
W215/5-A	L16180-D	180.0	135.0		881	878	874	771	656	517	340
W215/5	L16200-D	200.0	150.0		942	938	935	820	692	558	387
W215/6-AA	L16225-D	225.0	165.0		1020	1015	1010	907	771	607	387
W215/6-A	L16225-D	225.0	165.0		1074	1071	1066	945	804	640	427
W215/6	L16225-D	225.0	165.0		1130	1127	1122	984	830	673	427
W215/7-AA	L16250-D	250.0	185.0		1189	1181	1175	1043	879	681	471
W215/7-A	L16250-D	250.0	185.0		1240	1235	1227	1083	909	707	468

Dimensions & weights of pump with Water filled motor

Type Pump + Motor	ØM [inch]	ØE [inch]	Length [inch]			Gross weight [lbs]			Gross volume [ft³]		
			L1	L		Pump	Pump+Motor		Pump	Pump+Motor	
				1 ~	3 ~		1 ~	3 ~		1 ~	3 ~
W215/1-A + L6630-KP	5.59	9.29	31.10	-	70.20	110	-	296	4.1	-	5.2
W215/1 + L6640-KP	5.59	9.29	31.10	-	75.71	110	-	357	4.1	-	8.8
W215/2-AA + L8660-KH	7.48	9.41	38.03	-	85.72	128	-	600	4.3	-	11.8
W215/2-A + L8675-KH	7.48	9.41	38.03	-	87.72	128	-	631	4.3	-	12.1
W215/2 + L8690-H	7.48	9.41	38.03	-	94.45	128	-	717	4.3	-	12.9
W215/3-AA + L86100-H	7.48	9.41	44.96	-	103.23	146	-	758	5.1	-	13.9
W215/3-A + L86125-H	7.48	9.41	44.96	-	108.74	146	-	818	5.1	-	14.6
W215/3 + L86125-H	7.48	9.41	44.96	-	108.74	146	-	818	5.1	-	14.6
W215/4-AA + L86150-H	7.48	9.41	51.89	-	120.79	163	-	917	5.9	-	16.0
W215/4-A + L86150-H	7.48	9.41	51.89	-	120.79	163	-	917	5.9	-	16.0
W215/4 + L86150-H	7.48	9.41	51.89	-	120.79	163	-	917	5.9	-	16.0
W215/5-AA + L16180-D	9.45	9.84	58.82	-	130.71	181	-	1105	6.6	-	19.3
W215/5-A + L16180-D	9.45	9.84	58.82	-	130.71	181	-	1105	6.6	-	19.3
W215/5 + L16200-D	9.45	9.84	58.82	-	132.28	181	-	1135	6.6	-	19.3
W215/6-AA + L16225-D	9.45	9.84	65.75	-	141.18	198	-	1193	7.4	-	20.6
W215/6-A + L16225-D	9.45	9.84	65.75	-	141.18	198	-	1193	7.4	-	20.6
W215/6 + L16225-D	9.45	9.84	65.75	-	141.18	198	-	1193	7.4	-	20.6
W215/7-AA + L16250-D	9.45	9.84	84.49	-	161.89	216	-	1257	8.2	-	22.2
W215/7-A + L16250-D	9.45	9.84	84.49	-	161.89	216	-	1257	8.2	-	22.2

Note: ØE = For single cable motor maximum diameter of pump inclusive of cable guard.
For two cable motor maximum diameter of pump inclusive of cable guard will increase by 0.24 inch.

Flange connection is available on request.

All dimensions in inches unless otherwise noted.

Performance curves

Mixed flow 10" stainless steel submersible bore well pumps

W215

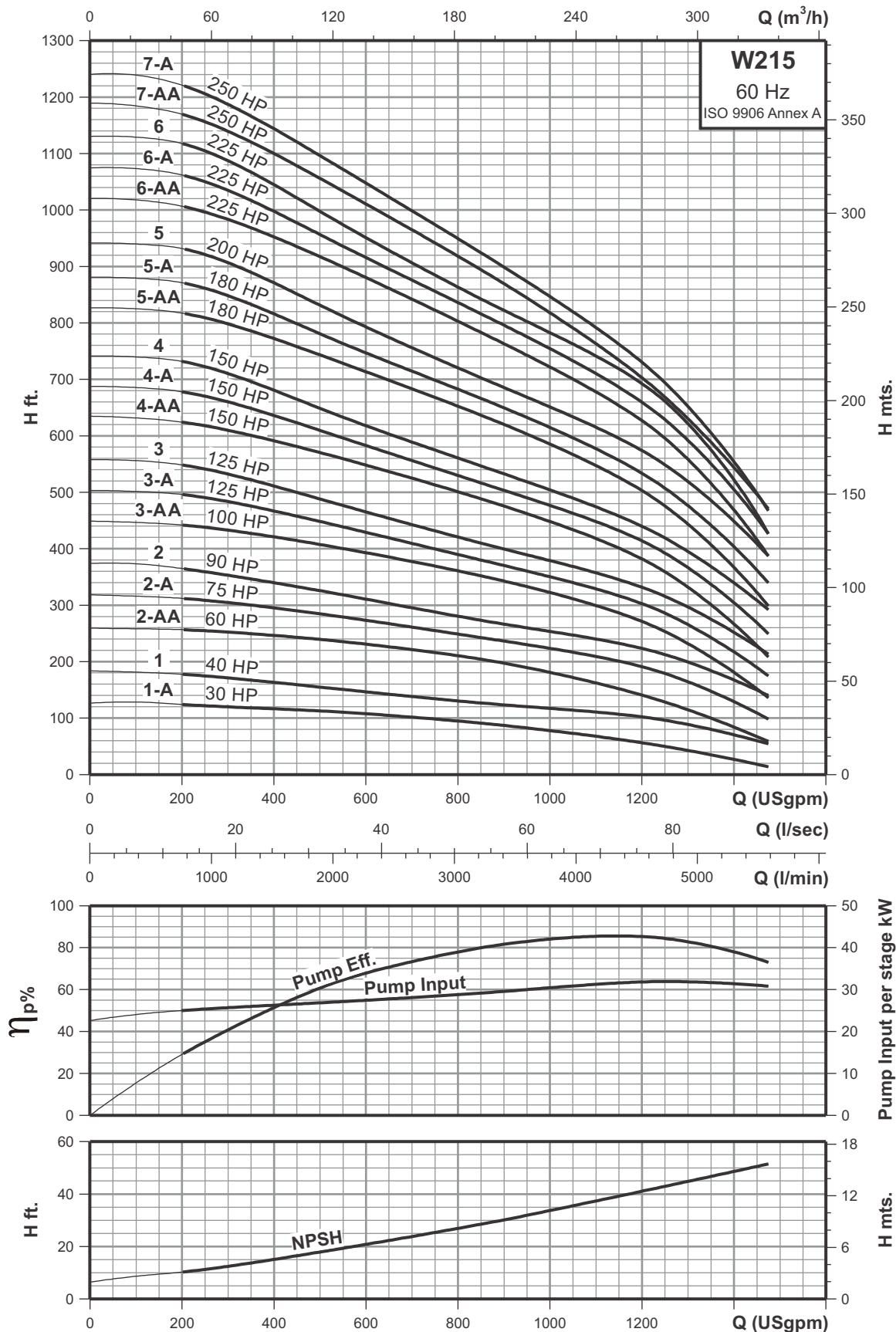

Friction loss tables

Friction loss table - SCH 40 steel pipe										
USgpm	USgph	0.5"	0.75"	1"	1.25"	1.5"	2"	2.5"	3"	4"
		ID 0.622"	ID 0.824"	ID 1.049"	ID 1.380"	ID 1.610"	ID 2.067"	ID 2.469"	ID 3.068"	ID 4.026"
Friction loss in feet of head per 100 feet of pipe										
2	120	4.8								
3	180	10.0	2.5							
4	240	17.1	4.2							
5	300	25.8	6.3	1.9						
6	360	36.5	8.9	2.7						
7	420	48.7	11.8	3.6						
8	480	62.7	15.0	4.5						
9	540	78.3	18.8	5.7						
10	600	95.9	23.0	6.9						
12	720		32.6	9.6	2.5	1.2				
14	840		43.5	12.8	3.3	1.5				
16	960		56.3	16.5	4.2	2.0				
20	1200		86.1	25.1	6.3	2.9				
25	1500			38.7	9.6	4.5	1.3			
30	1800			54.6	13.6	6.3	1.8			
35	2100			73.3	18.2	8.4	2.4			
40	2400			95.0	23.5	10.8	3.1	1.3		
45	2700				29.4	13.5	3.9	1.6		
50	3000				36.0	16.4	4.7	1.9		
60	3600				51.0	23.2	6.6	2.7		
70	4200				68.8	31.3	8.9	3.6	1.2	
80	4800				89.2	40.5	11.4	4.6	1.6	
90	5400					51.0	14.2	5.8	2.0	
100	6000					62.2	17.4	7.1	2.4	
120	7200						24.7	10.1	3.4	
140	8400						33.2	13.5	4.5	1.2
160	9600						43.0	17.5	5.8	1.5
200	12000						66.3	27.0	8.9	2.3
260	15600							45.0	14.8	3.7
300	18000							59.6	19.5	4.9

Friction loss tables

Friction loss table - SCH 40 PVC pipe										
USgpm	USgph	0.5"	0.75"	1"	1.25"	1.5"	2"	2.5"	3"	4"
		ID 0.622"	ID 0.824"	ID 1.049"	ID 1.380"	ID 1.610"	ID 2.067"	ID 2.469"	ID 3.068"	ID 4.026"
Friction loss in feet of head per 100 feet of pipe										
2	120	4.1								
3	180	8.7	2.2							
4	240	14.8	3.7							
5	300	22.2	5.7	1.8						
6	360	31.2	8.0	2.5						
7	420	41.5	10.6	3.3						
8	480	53.0	13.5	4.2						
9	540	66.0	16.8	5.2						
10	600	80.5	20.4	6.3	1.7					
12	720		28.6	8.9	2.3	1.1				
14	840		38.0	11.8	3.1	1.4				
16	960		48.6	15.1	4.0	1.9				
20	1200		60.5	22.8	6.0	2.8				
25	1500			38.7	9.1	4.3	1.3			
30	1800				12.7	6.0	1.8			
35	2100				16.9	8.0	2.4			
40	2400				21.6	10.2	3.0	1.1		
45	2700				28.0	12.5	3.8	1.4		
50	3000					15.4	4.6	1.7		
60	3600					21.6	6.4	2.3		
70	4200					28.7	8.5	3.0	1.2	
80	4800					36.8	10.9	3.8	1.4	
90	5400					45.7	13.6	4.8	1.8	
100	6000					56.6	16.5	5.7	2.2	
120	7200						23.1	8.0	3.0	
140	8400						30.6	10.5	4.0	1.1
160	9600						39.3	13.4	5.0	1.4
200	12000						66.3	20.1	7.6	2.1
260	15600							32.4	12.2	3.4
300	18000							42.1	15.8	4.4

Type of fitting and application	Pipe and fitting	Nominal size of fitting and pipe						
		0.5"	0.75"	1"	1.25"	1.5"	2"	2.5"
Friction loss in equivalent length of straight pipe in feet								
Insert coupling	Plastic	3	3	3	3	3	3	3
Threaded adapter (plastic to thread)	Plastic	3	3	3	3	3	3	3
90° standard elbow	Steel	2	2	3	4	4	5	6
	Plastic	2	2	3	4	4	5	6
Standard tee (flow through run)	Steel	1	2	2	3	3	4	4
	Plastic	1	2	2	3	3	4	4
Standard tee (flow through side)	Steel	4	5	6	7	8	11	13
	Plastic	4	5	6	7	8	11	13
Gate valve*	Steel	1	1	1	1	2	2	2
Swing check valve*	Steel	5	7	9	12	13	17	21

Note: Based on schedule 40 steel and plastic fittings.

* Friction loss figures are for screwed valves and are based on equivalent length of steel pipe.

Discharge rate table

Horizontal distance "X" in inches	Nominal pipe outer diameter "D"								
	1"	1.25"	1.5"	2"	2.5"	3"	4"	5"	6"
	Discharge rate (Q) (USgpm)								
4	6.9	11.6	15.9	26.4	37.2	58.6	99.6	155.9	228.0
5	8.5	14.5	19.8	33.5	46.8	73.2	124.7	197.9	287.9
6	10.3	17.7	24.0	39.6	56.3	87.4	149.8	233.8	341.8
7	11.9	20.6	27.7	46.8	66.0	102.0	175.1	275.8	401.8
8	13.5	23.5	31.7	52.8	74.2	117.6	199.2	311.7	455.7
9	15.3	26.4	35.7	60.0	84.0	131.8	224.3	353.7	515.7
10	16.9	29.3	39.9	66.0	93.5	146.4	249.4	389.7	569.6
11	18.8	31.2	43.9	73.2	103.0	160.6	274.7	431.7	629.5
12	20.3	34.9	46.8	79.3	112.8	176.2	299.8	467.9	683.7
13	22.2	37.8	51.5	86.4	121.3	190.7	323.9	509.9	743.6
14	24.0	40.7	55.7	92.5	130.8	205.0	349.0	539.7	797.5
15	25.6	43.6	59.4	99.6	140.3	219.5	374.1	587.8	851.4
16	27.2	46.8	63.4	105.7	149.8	235.1	399.4	623.7	911.4
17	28.8	49.7	67.6	112.8	159.6	249.4	423.5	665.7	971.4
18	30.6	52.3	71.6	118.6	168.0	263.9	448.6	707.7	1025.5
19	32.5	55.5	75.6	126.0	177.5	278.2	473.7	743.6	1085.5
20	34.1	58.4	79.5	133.1	187.0	292.7	499.0	779.6	1139.4
21	35.7	61.3	83.5	139.2	196.8	307.0	524.1	821.6	1199.3
22	37.5	64.2	87.4	146.4	206.3	322.6	548.2	863.6	1259.3
23	39.1	67.1	91.1	152.4	214.8	337.1	573.3	899.5	1313.2
24	40.9	70.0	95.1	159.6	224.3	351.3	598.4	935.4	1367.1
25	42.5	72.9	99.1	165.6	233.8	366.9	623.7	977.4	1427.1
26	44.1	75.8	103.0	172.8	243.6	381.5	648.8	1013.4	1481.2
27	46.0	78.7	107.0	178.6	253.1	395.7	672.8	1055.4	1541.2
28	47.8	81.6	111.2	186.0	261.5	410.3	697.9		
29	49.4	84.5	115.2	191.8	271.0	424.5	723.3		
30	51.0	87.4	119.1	199.2	280.6	440.1	748.4		
31			123.6	205.0	290.3	454.6			
32			127.1	212.4	299.8	468.9			
33			130.8	218.2	308.3	483.4			
34			135.5	225.6	317.8	497.7			
35			139.2	232.7	327.3	513.3			
36			142.7	238.5	337.1	527.8			

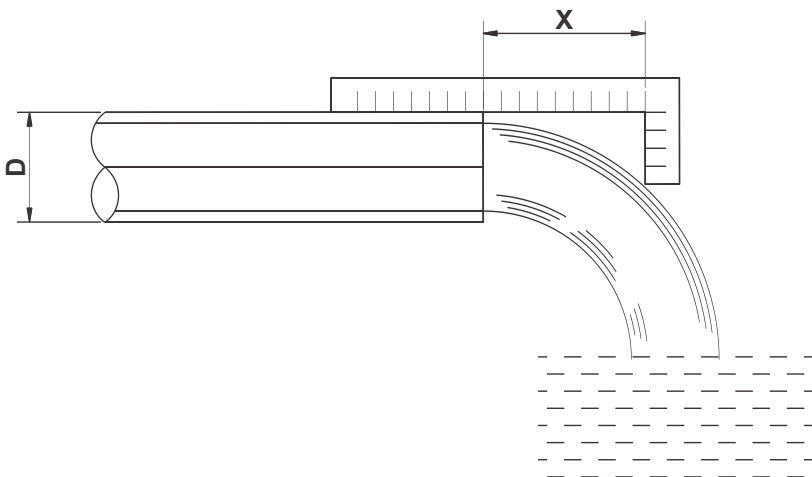

Note: X = Horizontal distance in inches
D = Nominal pipe diameter in inches
Q = Discharge in USgpm

Conversion tables

Volume (Flow)							
Litre per second l/s	Liter per minute l/min	Cubic metre per hour m ³ /hr	Cubic feet per hour ft ³ /hr	Cubic feet per minute ft ³ /min	Imp. gallon per minute lgpm	US gallon per minute USgpm	US barrel per day US barrel/day
1	60	3.600	127.1328	2.1189	13.1982	15.8504	543.4390
0.0167	1	0.0600	2.1189	0.0353	0.2200	0.2642	9.0570
0.2778	16.6667	1	35.3147	0.5886	3.6662	4.4029	150.9550
0.0079	0.4719	0.0283	1	0.0167	0.1038	0.1247	4.2750
0.4719	28.3168	1.6990	60.0000	1	6.2288	7.4805	265.4750
0.0758	4.5461	0.2728	9.6326	0.1605	1	1.2010	41.1750
0.0631	3.7854	0.2271	8.0208	0.1337	0.8327	1	34.2860
0.0020	0.1100	0.0060	0.2400	0.0040	0.0240	0.0310	1

Volume (Capacity)					
Cubic metre m ³	Litre L	Millilitre mL	Imperial gallon Imp. gal	Us gallon USgal	Cubic feet ft ³
1	1000	1 x 10 ⁶	219.9692	264.1721	35.3147
0.001	1	1000	0.2200	0.2642	0.0353
1 x 10 ⁻⁶	0.001	1	0.0002	0.0003	3.515 x 10 ⁻⁷
0.0045	4.5461	4546.09	1	1.2009	0.1605
0.0038	3.7854	3785.4118	0.8327	1	0.1337
0.0283	28.3168	28316.8488	6.2288	7.4805	1

Liquid head and pressure								
Newton per square metre N/m ²	Kilo Pascal kPa	bar	Kilogram force per square centimetre kgf/cm ²	Pound force per square inch psi	Feet of water ft H ₂ O	Meters of water m H ₂ O	Millimeter of mercury mm Hg	Inch of mercury in Hg
1	0.001	1 x 10 ⁻⁵	1.02 x 10 ⁻⁵	1.45 x 10 ⁻⁴	3.35 x 10 ⁻⁴	1.02 x 10 ⁻⁴	0.0075	2.95 x 10 ⁻⁴
1000	1	0.010	0.0102	0.1450	0.3346	0.1020	7.5	0.2953
1 x 10 ⁵	100	1	1.0197	14.5038	33.4553	10.1973	750.0638	29.5300
98066.50	98.0665	0.9807	1	14.2233	32.8084	10	735.5613	28.9590
6894.76	6.8949	0.0689	0.0703	1	2.3067	0.7031	51.7151	2.0360
2989.07	2.9891	0.0299	0.0305	0.4335	1	0.3048	22.4199	0.8827
9806.55	9.8066	0.0981	0.1000	1.4223	3.2808	1	73.5554	2.8959
133.32	0.1333	0.0013	0.0014	0.0193	0.0446	0.0136	1	0.0394
3386.39	3.3864	0.0339	0.0345	0.4912	1.1329	0.3453	25.4001	1

Conversion tables

Length					
Metre m	Feet ft	Yard yd	Centimetre cm	Millimeter mm	Inch in
1	3.2808	1.0936	100	1000	39.3701
0.3048	1	0.3333	30.48	304.8	12
0.9144	3	1	91.14	914.4	36
0.01	0.0328	0.0109	1	10	0.3937
0.001	0.0033	0.0011	0.1	1	0.0394
0.0254	0.0833	0.0278	2.54	25.4	1

Mass				
Kilogram kg	Pound lb	Hundred weight (long)	Tonne t	
1	2.2046	0.0199	0.001	
0.4536	1	0.009	0.0005	
50.3592	111.02	1	0.0504	
1000	2204.6226	19.8573	1	

Temperature		
To convert from	To	Use formula
Temperature Celsius (C) - tC	Temperature Kelvin (K) - tK	$tK = tC + 273.15$
Temperature Fahrenheit (F) - tF	Temperature Kelvin (K) - tK	$tK = (tF + 459.67) / 1.8$
Temperature Celsius (C) - tC	Temperature Fahrenheit (F) - tF	$tF = 1.8tC + 32$
Temperature Fahrenheit (F) - tF	Temperature Celsius (C) - tC	$tC = (tF - 32) / 1.8$
Temperature Kelvin (K) - tK	Temperature Celsius (C) - tC	$tC = tK - 273.15$
Temperature Kelvin (K) - tK	Temperature Fahrenheit (F) - tF	$tF = 1.8tK - 459.67$

Power		
HP	W	kW
1 (SI)	746	0.746
1 (Metric)	736	0.736
1.34×10^{-3}	1 (SI)	0.001
1.36×10^{-3}	1 (Metric)	0.001
1.3405	1000	1 (SI)
1.3587	1000	1 (Metric)

LUBI INDUSTRIES LLP

Near Kalyan Mills, Naroda Road, Ahmedabad-380 025. INDIA.
Phone : +91 - 79 - 30610100, Fax No. :+91 - 79 - 30610300.

Sales Enquiries: mktsales@lubipumps.com, expsales@lubipumps.com

www.lubipumps.com



REV.01 / 01-12-2014

Product Improvement is a continuous process at 'LUBI'. The data given in this publication is therefore subject to revision.

Toll Free Service Hotline : 1800 3000 3055